

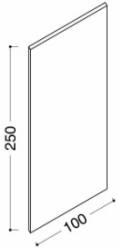

ALLESTIMENTI PER STAND PREALLESTITI

La presentazione allegata serve a suggerire una serie di soluzioni differenti tra di loro che vi aiuteranno a poter meglio valutare le vs. esigenze estetiche, tecniche ed economiche.

Cod AA001



Pannello
100x250 cm
lavabile bianca
€/pz 15,00 + iva

Cod AA002

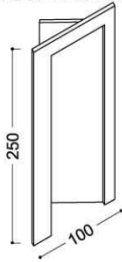

Pannello - Porta
Dim. 100x250 cm
lavabile bianca
€/pz 80,00 + iva

Cod AA003

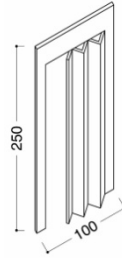

Porta a soffietto
Dim. 100x250 cm
Colore bianco
€/pz 80,00 + iva

Cod AA004

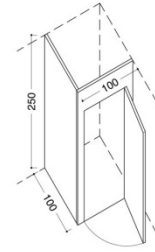

Magazzino
100x100 con porta
lavabile bianca
€/pz 95,00 + iva

Cod AA005

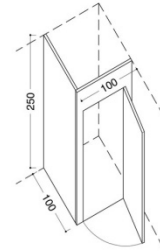

Magazzino
200x100 con porta
lavabile bianca
€/pz 105,00 + iva

Cod AA006

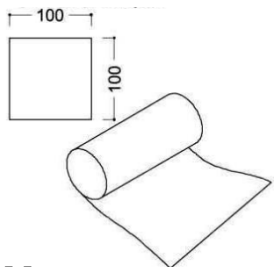

Moquette
(colori su richiesta)
€/mq 5,80 + iva

Cod AA007

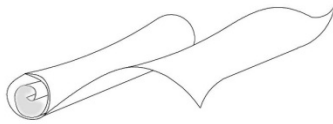

Celino teso per soffitto
(secondo disponibilità)
€/mq 15,00 + iva

Cod AA008



Fascione per grafica
Dimensione 300x40
Colore bianco
€/ml 27,00 + iva

Cod AA009



Grafica in lettere adesive
(file a Vs. cura)
€/mq 30,00 + iva

Cod AA010



Grafica immagini e testi a colori
(file a Vs. cura)
€/mq 60,00 + iva

Cod AA011

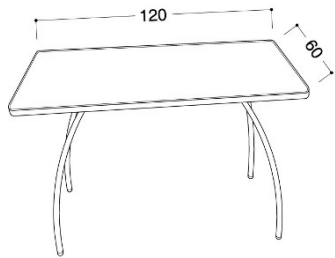

Scrivania
Cm 120x60 h.cm 75
Piano e gambe
colore alluminio
€/pz 23,50 + iva

Cod AA012

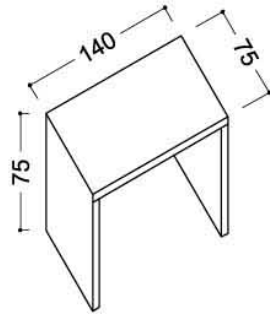

Scrivania
Cm 140x70 h. cm 75
Piano e gambe
in legno chiaro
€/pz 23,50 + iva

Cod AA013

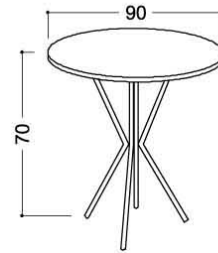

Tavolo bar
h. 70 (tondo/quadro)
Colore secondo
disponibilità
€/pz 40,00 + iva

Cod AA014

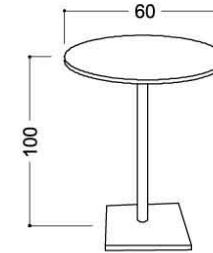

Tavolo bistrot
Tondo h. 100
Colore secondo
disponibilità
€/pz 40,00 + iva

Cod AA015

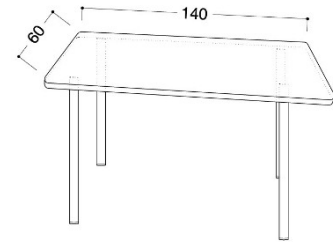

**Tavolo piano
in vetro**
Altezza cm 70
€/pz 15,00 + iva

Cod AA016

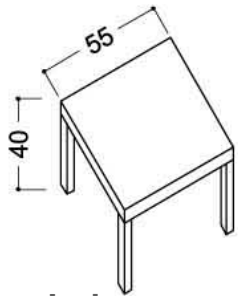

Tavolo basso
Cm 50x50 h. cm 40
Colore secondo
disponibilità
€/pz 12,00 + iva

Cod AA017

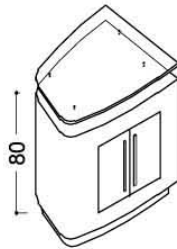

Postazione pc
Colore secondo
disponibilità.
€/pz 80,00 + iva

Cod AA018

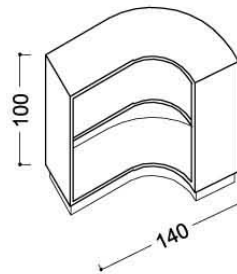

Desk
Colore secondo
disponibilità.
€/pz 120,00 + iva

Cod AA019

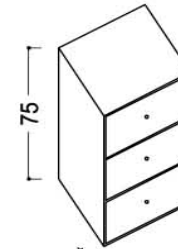

Cassettiera
(secondo
disponibilità)
€/pz 30,00 + iva

Cod AA020

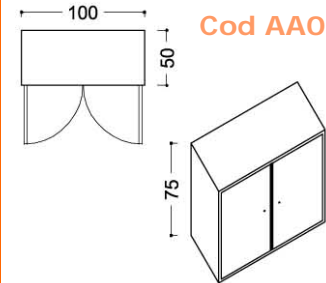

Mobile basso
(secondo
disponibilità)
€/pz 30,00 + iva

Cod AA021



**Sedia mod.
Regista**
Colore nero
€ 5,50 + iva

Cod AA022



Sedia in plastica
Colore grigio
€/pz 7,00 + iva

Cod AA023



Sedia con rotelle
Colore secondo
disponibilità
€/pz 10,00 + iva

Cod AA024

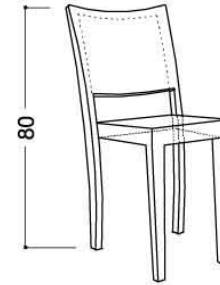

Sedia in plexiglass
Trasparente – gialla
- arancio
€/pz 12,00 + iva

Cod AA025



Sedia imbottita
Colore grigio
€/pz 10,00 + iva

Cod AA026

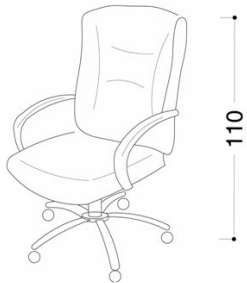

**Poltrona in pelle
con braccioli**
Colore nero
€/pz 40,00 + iva

Cod AA027

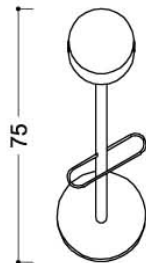

Sgabello
(secondo
disponibilità)
€/pz 12,00 + iva

Cod AA028

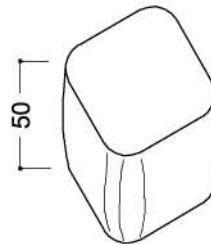

Puff
(secondo
disponibilità)
€/pz 12,00 + iva

Cod AA029

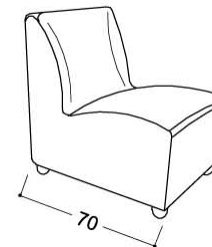

Poltrona
(secondo
disponibilità)
€/pz 25,00 + iva

Cod AA030

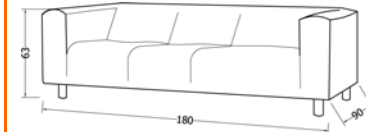

Divano
(secondo
disponibilità)
€/pz 95,50 + iva

Cod AA031

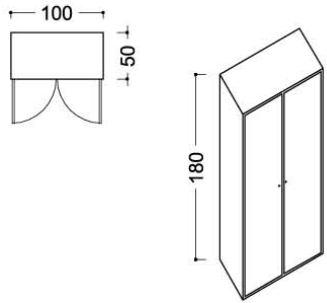

Mobile alto
(secondo disponibilità)
€/pz 80,00 + iva

Cod AA032

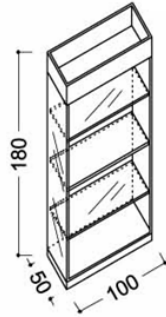

Vetrina
(secondo disponibilità)
€/pz 120,00 + iva

Cod AA033

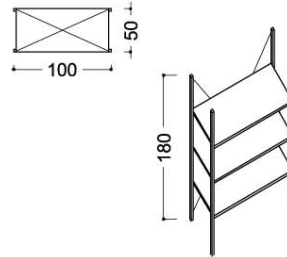

Scaffale per
magazzino (secondo
disponibilità)
€/pz 23,50 + iva

Cod AA034

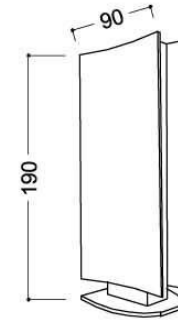

Palina per grafica
cm 90x190
€/pz 36,00 + iva
(grafica esclusa)

Cod AA035

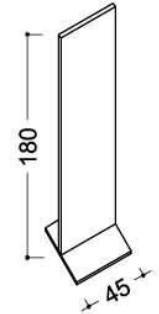

Palina per grafica
cm 45x180
€/pz 20,00 + iva
(grafica esclusa)

Cod AA036

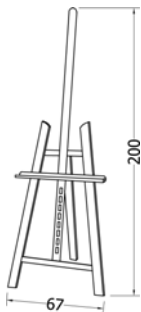

Cavalletto
per
pannelli grafici
€/pz 16,00 + iva

Cod AA037

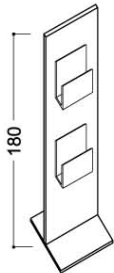

Porta depliant
(secondo
disponibilità)
€/pz 60,00 + iva

Cod AA038

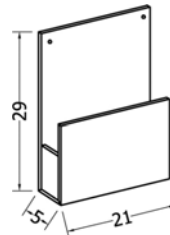

Tasca depliant
in plexiglass da
parete
€/pz 5,00 + iva

Cod AA039



Gettacarte
(secondo
disponibilità)
€/pz 4,50 + iva

Cod AA040

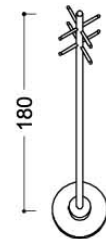

Appendiabiti
(secondo
disponibilità)
€/pz 11,50 + iva

Cod AA041

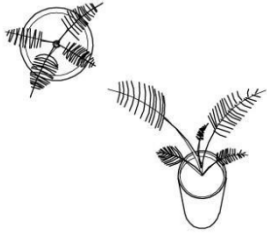

Addoppi floreali
Pianta bassa –
tipo potus - felce
€ 35,00 + iva

Cod AA042

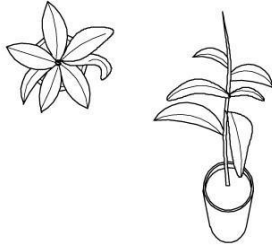

Addoppi floreali
Pianta alta –
tipo ficus - kentia
€/pz 55,00 + iva

Cod AA043

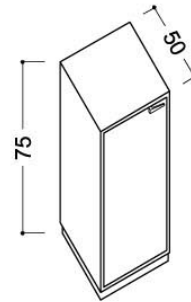

Frigorifero basso
(secondo
disponibilità)
€/pz 30,00 + iva

Cod AA044



**Macchinetta
per il caffè**
(con 100 cialde)
€/pz 100,00 + iva

Cod AA045

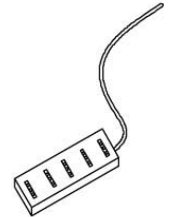

Multipresa
€/pz 10,00 + iva

Cod AA046

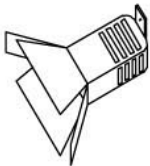

**Faro di
illuminazione**
€/pz 25,00 + iva

Cod AA047



**Personal computer
con modem**
€/pz 130,00 + iva

Cod AA048

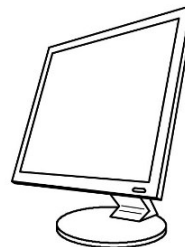

Monitor tft
15" – 17"
€/pz 100,00 + iva

Cod AA049



Stampante
Laser b/n
(esclusi materiali a consumo)
€/pz 200,00 + iva

Cod AA050

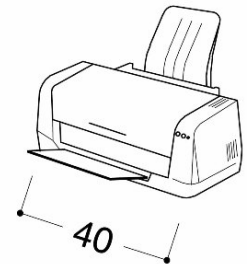

Stampante
A colori laser jet
(esclusi materiali a consumo)
€/pz 150,00 + iva

Cod AA051



Telefax
Carta comune b/n
(esclusi materiali a consumo)
€/pz 100,00 + iva

Cod AA052



Fotocopiatrice
b/n
(esclusi materiali a consumo)
€/pz 400,00 + iva

Cod AA053

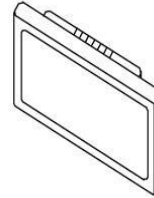

Plasma
Monitor 22"
€/pz 180,00 + iva

Cod AA054

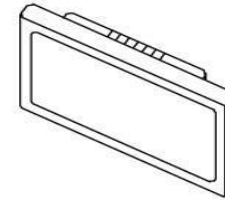

Plasma
Monitor 42"
€/pz 200,00 + iva

Cod AA055

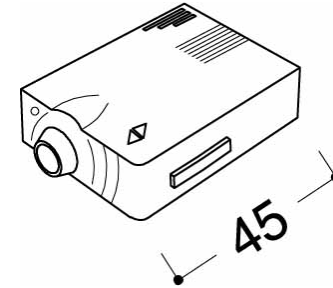

Videoproiettore
LCD 1000 ansi
€/pz 500,00 + iva

Cod AA056

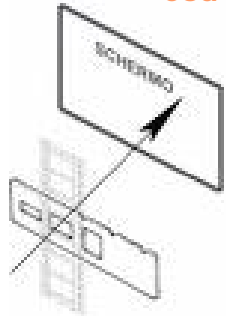

Schermo
per videoproiettore
€/pz 40,00 + iva
Costo al giorno

Cod AA057

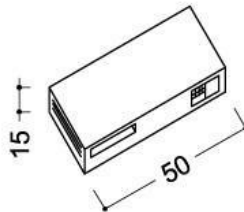

Vhs
€/pz 30,00 + iva

Cod AA058

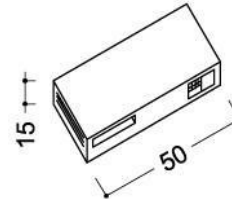

Dvd
€/pz 60,00 + iva

Cod AA059

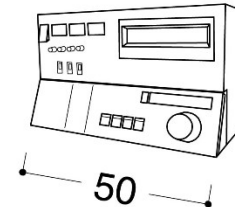

Lettore beta
€/pz 200,00 + iva
Costo al giorno

Cod AA060



Amplificazione
Valutabile dopo
briefing.

Tutti gli importi indicati si intendono iva esclusa.

I beni sono da considerarsi **a noleggio** per la durata della manifestazione ed inclusi di trasporto, montaggio e ritiro al termine dell'evento.

Tutti le richieste dovranno pervenire alla Merlo Rent S.r.l. compilando un apposito modulo d'ordine ed inviate a mezzo fax al nr. +39.06.9905977.

Il pagamento dovrà avvenire tramite bonifico bancario.

La scadenza per la presentazione delle richieste è fissata per il giorno **05 Settembre 2011**.

La richiesta è a tutti gli effetti impegnativa per il partecipante.

In caso di ritardata presentazione, la Merlo Rent Srl (che comunque si riserva il diritto di non accettarla) addebiterà il relativo importo con le maggiorazioni pari al 10%

Tutte le richieste pervenute in ritardo saranno evase solamente dopo aver espletato tutti gli impegni prenotati dagli altri espositori in tempi debiti in modo da poter verificare la reale residua disponibilità. In ogni caso la consegna dei materiali potrà subire dei ritardi rispetto il giorno di apertura lavori.



Piazza delle Muse, 8 – 00197 Roma Italy
Via di Zambra, 59 – 00052 Cerveteri (RM) Italy
Tel. +39.06.99.04.700 r.a.
Fax +39.06.99.05.977

www.merlorentsrl.it
info@merlorentsrl.it
