

Effective: October 1999

Supersedes I.L. 41-133R, Dated August 1998

(I) Denotes Changed Since Previous Issue



Types IRP, IRC and IRD Directional Overcurrent Ground Relays



Before putting relays into service, remove all blocking which may have been inserted for the purpose of securing the parts during shipment, make sure that all moving parts operate freely, inspect the contacts to see that they are clean and close properly, and operate the relay to check the settings and electrical connections.

1.0 APPLICATION

These relays are ground directional overcurrent relays which are used for the protection of transmission lines and feeder circuits. Both the time overcurrent and instantaneous overcurrent units are directionally controlled.

The type IRP relay is potential polarized. The type IRC relay is current polarized. The type IRD relay is a dual polarized relay which can be polarized from a potential source, from a local ground source or from both simultaneously.

2.0 CONSTRUCTION AND OPERATION

The various types of relays consist of a directional unit or units (D), an auxiliary switch (CS-1 or a telephone relay TR-1), a time-overcurrent unit (CO), an instantaneous overcurrent unit (I), an instantaneous overcurrent unit transformer, and two indicating contactor switches (ICS/I) and (ICS/T). The principle component parts of the relays and their locations are shown in Figures 1 through 6, starting on page 19.

2.1 TIME-OVERCURRENT UNIT (CO)

The electromagnets for the types IR-5, IR-6, IR-7,

IR-8 and IR-9 relays have a main tapped coil located on the center leg of an "E" type laminated structure that produces a flux which divides and returns through the outer legs. A shading coil causes the flux through the left leg to lag the main pole flux. The out-of-phase fluxes thus produced in the air gap cause a contact closing torque.

The electromagnet for the type IR-2 and IR-11 relays has a main coil consisting of a tapped primary winding and a secondary winding. Two identical coils on the outer legs of the lamination structure are connected to the main coil secondary in a manner so that the combination of all the fluxes produced by the electromagnet result in out-of-phase fluxes in the air gap. The out-of-phase air gap fluxes produced cause a contact closing torque.

The dc indicating contactor switch is a small clapper type device. A magnetic armature, to which leaf-spring mounted contacts are attached, is attracted to the magnetic core upon energization of the switch. When the switch closes the moving contacts bridge two stationary contacts, completing the trip circuit. Also during this operation two fingers on the armature deflect a spring located on the front of the switch, which allows the operation indicator target to drop.

The front spring, in addition to holding the target, provides restraint for the armature and thus controls the pickup value of the switch.

2.2 DIRECTIONAL UNIT (D)

The directional unit is a product induction cylinder type unit operating on the interaction between the polarizing circuit flux and the operating circuit flux.

Mechanically, the directional unit is composed of four basic components: A die-cast aluminum frame; an

All possible contingencies which may arise during installation, operation or maintenance, and all details and variations of this equipment do not purport to be covered by these instructions. If further information is desired by purchaser regarding this particular installation, operation or maintenance of this equipment, the local ABB Power T&D Company Inc. representative should be contacted.

electromagnet; a moving assembly; and a molded bridge.

The frame serves as the mounting structure for the magnetic core. The magnetic core which houses the lower pin bearing is secured to the frame by a locking nut. The bearing can be replaced, if necessary, without having to remove the magnetic core from the frame.

The electromagnet has two series-connected polarizing coils mounted diametrically opposite one another; two series-connected operating coils mounted diametrically opposite one another; two magnetic adjusting plugs; upper and lower adjusting plug clips, and two locating pins. The locating pins are used to accurately position the lower pin bearing, which is mounted on the frame, with respect to the upper pin bearing, which is threaded into the bridge. The electromagnet is secured to the frame by four mounting screws.

The moving element assembly consists of a spiral spring, contact carrying member, and an aluminum cylinder assembled to a molded hub which holds the shaft. The shaft has removable top and bottom jewel bearings. The shaft rides between the bottom pin bearing and the upper pin bearing with the cylinder rotating in an air gap formed by the electromagnet and the magnetic core.

The bridge is secured to the electromagnet and frame by two mounting screws. In addition to holding the upper pin bearing, the bridge is used for mounting the adjustable stationary contact housing. The stationary contact housing is held in position by a spring type clamp. The spring adjuster is located on the underside of the bridge and is attached to the moving contact arm by a spiral spring. The spring adjuster is also held in place by a spring type clamp.

With the contacts closed, the electrical connection is made through the stationary contact housing clamp, to the moving contact, through the spiral spring out to the spring adjuster clamp.

2.3 AUXILIARY SWITCH (CS-1 OR TR-1)

The CS-1 switch is a small solenoid type dc switch. A cylindrical plunger, with a silver disc mounted on its lower end, moves in the core of the solenoid. As the plunger travels upward, the disc bridges the silver stationary contacts.

The TR-1 switch is a telephone relay. A tapped resistor is used to enable one to use the auxiliary switch on a 24, 48, 125 or 250 volt dc system connected per Figure 26, page 40. The operation of the CS-1 or TR-1 switch is controlled by the directional unit (D) which in turn directionally controls the time-overcurrent unit (CO). When sufficient power flows in the tripping direction, the auxiliary switch operates and bridges the lag coil of the time-overcurrent unit (CO) permitting this unit to operate.

2.4 INSTANTANEOUS OVERCURRENT UNIT (I)

The instantaneous overcurrent unit is similar in construction to the directional unit. The time phase relationship of the two air gap fluxes necessary for the development of torque, is achieved by means of a capacitor connected in series with one pair of pole windings.

The normally-closed contact of the directional unit is connected across one pair of pole windings of the instantaneous overcurrent unit as shown in the internal schematics. This arrangement short-circuits the operating current around the pole windings, preventing the instantaneous overcurrent unit from developing torque. If the directional unit should pick up for a fault, this short-circuit is removed, allowing the instantaneous overcurrent contact to commence closing almost simultaneously with the directional contact for high speed operation. Total operating time is shown in Figures 23 (page 38) and 24 (page 38).

2.5 INSTANTANEOUS OVERCURRENT UNIT TRANSFORMER

This transformer is of the saturating type for limiting the energy to the instantaneous overcurrent unit at higher values of fault current and to reduce ct burden. The primary winding is tapped and these taps are brought out to a tap block for ease in changing the pick-up of the instantaneous overcurrent unit. The use of a tapped transformer provides approximately the same energy level at a given multiple of pickup current for any tap setting, resulting in one time curve throughout the range of the relay.

Across the secondary is connected a non-linear resistor known as a varistor. The effect of the varistor is to reduce the voltage peaks applied to the overcurrent unit and phase shifting capacitor.

3.0 CHARACTERISTICS

The time characteristics of the directional overcurrent relays are designated by specific numbers as indicated below (e.g., IRD-8).

Time Characteristics	Designation
Short Time	2
Long Time	5
Definite Time	6
Moderately Inverse Time	7
Inverse Time	8
Very Inverse Time	9
Extremely Inverse Time	11

The relays are available in the following current ranges:

Instantaneous Overcurrent Unit

Range	Taps					
0.5-2 Amps	0.5	0.75	1.0	1.25	1.5	2
1-4	1.0	1.5	2.0	2.5	3.0	4.0
2-8	2	3	4	5	6	8
4-16	4	6	8	9	12	16
10-40	10	15	20	24	30	40
20-80	20	30	40	48	60	80

Time Overcurrent Unit

Range	Taps						
.5-2.5	0.5	0.6	0.8	1.0	1.5	2.0	2.5
2-6	2	2.5	3	3.5	4	5	6
4-12	4	5	6	7	8	10	12

The tap value is the minimum current required to just close relay contacts.

The time vs. current characteristics for the time-overcurrent unit are shown in Figures 16 to 22 (page 31 to page 37). These characteristics give the contact closing time for the various time dial settings when the indicated multiples of tap value current are applied the relay.

4.0 TIME CURVES

The times curves for the IRD relay are shown in Figures 23 (page 38) and 24 (page 38). Figure 23 consists of three curves which are:

1. Directional Unit opening times for current and voltage polarized.
2. Directional Unit closing time for current and voltage polarized.
3. Directional Unit closing time for 1 volt, voltage polarized.

Figure 24 shows the instantaneous overcurrent unit closing time.

The voltage polarized curve B begins to deviate from curve A for less than 5 volts.

Both the directional unit and the overcurrent unit must operate before the trip circuit can be completed. Hence, the unit which takes the longer time to operate determines when the breaker will be tripped. The overcurrent unit contacts cannot operate until the back contacts of directional unit open; therefore, the total time for overcurrent unit to operate is its closing time given in Figure 24 (page 38) plus the directional unit opening time given in Figure 23. The total closing time for the directional unit is given in Figure 23. The two examples below will serve to illustrate the use of the curves.

Example 1: Using the formulas and definition of symbols on Figure 23,

Let: $I_{pol} = 2$ amps.
 $I_{op} = 2.31$ amps.
 Tap Value (T) = 0.5 amp.
 $\phi - 40^\circ = 0^\circ$

(For timing unit, assume CO-9 with 1/2 time dial setting)

For current polarized relay:

$$MPP = \frac{I_{op} I_{pol} \cos(\phi - 40^\circ)}{0.25}$$

$$MPP = \frac{(2.31)(2)}{0.25} = 18.5$$

Referring to Figure 23 at multiples of product pickup of 18.5, the directional unit operating time is about 11 ms, and the closing time for this unit is 56 ms.

For overcurrent unit:

$$\text{Multiples of pickup} = \frac{I_{op}}{T} = \frac{2.31}{0.5} = 4.6$$

Entering the curve in Figure 24 at multiples of pickup equal to 4.6, the closing time for instantaneous overcurrent is 16 ms. However, the total operating time for the overcurrent unit is 16 plus 11, which is the opening time of back contacts of the directional unit, or 27 ms total operating time for overcurrent unit. The total time for directional unit is 56 ms, and, since this is the longest time, 56 ms is the total operating time of the instantaneous overcurrent circuit.

Entering the curve in Figure 21 (page 36) at 4.6, the 1/2 time dial setting gives 140 ms. The total time for the time-overcurrent circuit is 56 ms directional unit time plus 16 ms time Aux plus 140 ms = 212 ms.

Example 2:

$$\begin{aligned} \text{Let: } I_{pol} &= 20 \text{ amps} \\ I_{op} &= 23.1 \text{ amps} \\ T(\text{tap}) &= 1 \text{ amp} \\ \phi - 40^\circ &= 0^\circ \end{aligned}$$

$$MPP = \frac{I_{op} I_{pol} \cos(\phi - 40^\circ)}{0.25}$$

$$MPP = \frac{(20)(23.1)}{0.25} = 1850$$

Entering Figure 23, (page 38) the directional unit closing time is 12 ms, and the opening time of its back contacts is 1 ms. The total operating time for the directional unit is 12 ms.

For overcurrent unit:

$$\text{Multiples of pickup} = \frac{I_{op}}{T} = \frac{23.1}{1} = 23.1$$

Referring to Figure 24, (page 38) the overcurrent unit contact closing time is about 14 ms. Therefore, the total operating time for this unit is 14 plus 1 = 15 ms. In this case the total operating time of relay is 15 ms.

Figure 21 (page 36) gives an operating time of about 50 ms. The time-overcurrent circuit is 12 plus 16 plus 50 ms = 78 ms.

4.1 TRIP CIRCUIT

The relay contacts will safely close 30 amperes at

250 volts dc and the seal-in contacts of the indicating contactor switches will safely carry this current long enough to trip a circuit breaker.

The indicating contactor switch has two taps that provide a pickup setting of 0.2 or 2 amperes. To change taps requires connecting the lead located in front of the tap block to the desired setting by means of a screw connection.

4.2 CONTACTS

The moving contact assembly has been factory adjusted for low contact bounce performance and should not be changed.

The set screw in each stationary contact has been factory adjusted for optimum follow and this adjustment should not be disturbed.

4.3 TRIP CIRCUIT CONSTANTS

Indicating Contactor Switch

0.2 ampere tap - 6.5 ohms dc resistance

2.0 ampere tap - 0.15 ohms dc resistance

4.4 AUXILIARY SWITCH (CS-1 OR TR-1)

The CS-1 switch has a dc resistance of 1165 ohms. The TR-1 telephone relay has a dc resistance of 1500 ohms.

4.5 TYPE IRP RELAY

The IRP relay is designed for potential polarization and has its maximum torque when the current lags the voltage by approximately 60 degrees. The shifting of the maximum torque angle is accomplished by the use of an internally mounted phase shifter as shown in the internal schematic.

The directional unit minimum pick-up is approximately 1 volt and 2 amperes at its maximum torque angle for the directional units used with the 0.5 to 2.5 and 2 to 6 ampere range time overcurrent units. For the directional units used with the 4-12 ampere range time overcurrent units the minimum pick-up is 1 volt and 4 amperes.

4.6 TYPE IRC RELAY

The IRC relay is designed for current polarization and has its maximum torque when the operating current leads the polarizing current by approximately 40°.

The directional unit minimum pick-up is 0.5 ampere

in each winding at the maximum torque angle for the directional units used with the 0.5 to 2.5 and 2 to 6 ampere range time overcurrent units. For the directional units used with the 4-12 ampere range time overcurrent units the minimum pickup is 1 ampere.

4.7 TYPE IRD RELAY

The IRD relay utilizes a directional unit similar to the IRC relay and a directional unit and phase-shifting circuit similar to those in the IRP relay.

The current-polarized directional unit of the IRD relay operates on residual currents while the potential-polarized directional unit of the IRD relay operates on residual voltage and residual current.

For the directional units used with the 0.5 to 2 and 2 to 6 ampere time overcurrent units, the minimum pick-up of the current polarized unit is 0.5 ampere in each winding at the maximum torque angle. The minimum pick-up for the voltage polarized unit is 1 volt and 2 amperes with the current lagging voltage by 60°.

For the directional units used with the 4 to 12 ampere range time overcurrent units, the minimum pick-up is 1 ampere for the current-polarized directional unit and 1 volt and 4 amperes for the voltage-polarized directional unit.

5.0 SETTINGS

5.1 TIME OVERCURRENT UNIT (CO)

The time overcurrent unit settings can be defined either by tap setting and dial position or by tap setting and a specific time of operation at some current multiple of the tap setting (e.g. 4 tap setting, 2 time dial position or 4 tap setting, 0.6 seconds at 6 times tap value current).

To provide selective circuit breaker operation, a minimum coordinating time of 0.3 seconds plus circuit breaker time is recommended between the relay being set and the relays with which coordination is to be effected.

The connector screws on the tap plate above the time dial makes connections to various turns on the operating coil. By placing this screw in the various tap plate holes, the relay will just close its contacts at the corresponding current 4-5-6-7-8-10-12 amperes, or as marked on the tap plate.



Since the tap block connector screw carries operating current, be sure that the screw is turned tight.

5.2 INSTANTANEOUS RECLOSING

The factory adjustment of the CO unit contacts provides a contact follow. Where circuit breaker reclosing will be initiated immediately after a trip by the CO contact, the time of the opening of the contacts should be a minimum. This condition is obtained by loosening the stationary contact mounting screw, removing the contact plate and then replacing the plate with the bent end resting against the contact spring. With this change and the contact mounting screw tightened, the stationary contact will rest solidly against its backstop.

5.3 INSTANTANEOUS OVERCURRENT UNIT (I)

The only setting required is the pickup current setting which is made by means of the connector screw located on the tap plate. By placing the connector screw in the desired tap, the relay will just close its contacts at the tap value current.



Since the tap block connector screw carries operating currents, be sure that the screw is turned tight.

5.4 DIRECTIONAL UNITS (D)

No setting is required.

5.5 INDICATING CONTACTOR SWITCH (ICS/I AND ICS/T)

The setting required on the ICS units is the selection of the 0.2 or 2.0 ampere tap setting. This selection is made by connecting the lead located in front of the tap block to the desired setting by means of the connecting screw.

5.6 AUXILIARY SWITCH (CS-1 OR TR-1)

No setting required on the auxiliary switch except for the selection of the required 24, 48, 125 or 250 voltage on the tapped resistor. This connection can be made by referring to Figure 26 (page 40).

6.0 INSTALLATION

The relays should be mounted on switchboard panels or their equivalent in a location free from dirt, moisture, excessive vibration and heat. Mount the relay vertically by means of the rear mounting stud or studs for the type FT projection case or by means of the four mounting holes on the flange for the semi-flush type FT case. Either the stud or the mounting screws may be utilized for grounding the relay. External toothed washers are provided for use in the locations shown on the outline and drilling plan to facilitate making a good electrical connection between the relay case, its mounting screws or studs, and the relay panel. Ground Wires should be affixed to the mounting screws or studs as required for poorly grounded or insulating panels. Other electrical connections may be made directly to the terminals by means of screws for steel panel mounting or to the terminal stud furnished with the relay for thick panel mounting. The terminal stud may be easily removed or inserted by locking two nuts on the stud and then turning the proper nut with a wrench.

For detail information on the FT case refer to I.L. 41-076.

The external ac connections of the directional overcurrent relays are shown in Figures 13, 14, and 15 (on page 28, page 29, and page 30). If no voltage polarizing source is to be connected to the IRD relay, short-circuit the voltage polarizing circuit at the terminals of the relay.

6.1 REVERSED CONTACTS

In installations where the relay could be exposed to unusual shock or jarring, the possibility of inadvertent contact closure can be reduced by reversing the orientation of the directional unit contacts. Contact arrangement and wiring would be reversed on the directional unit. Its contact would then mechanically close in a direction opposite to that of the instantaneous unit contact. Electrical characteristics and external connections to the relay would not be affected. Field modifications can be made per the following procedures.

1. Reverse the leads on the stationary contacts of the directional unit. For the IRD, reverse the leads on both directional units.

2. Reverse the leads to switch jaw terminals 6 and 7. For the IRD, also reverse leads to switch jaw terminals 4 and 5.
3. Move the spring adjuster on each directional unit such that the left hand contacts are normally closed.
4. Remove, then reverse the right hand and left hand stationary contacts on each directional unit. Adjust the left hand contact until it just makes with the moving contact, then advance it an additional 1/2 turn in. Now adjust the right hand stationary contact until it just makes with the moving contact, then screw it out 3/4 turn for a contact gap of .020" to .024".
5. Calibrate each directional unit per procedures beginning at section 7.4.1.c.

For relays whose contacts have been reversed, it is recommended that a sub letter "R" be added to the nameplate at the end of the style number to designate that the relay has reversed contacts. The new schematics for modified relays are 9654A56, 9654A57, 9654A58.

7.0 ADJUSTMENTS AND MAINTENANCE

The proper adjustments to insure correct operation of this relay have been made at the factory. Upon receipt of the relay, no customer adjustments, other than those covered under "SETTINGS" (page 5), should be required.

7.1 ACCEPTANCE CHECK

The following check is recommended to insure that the relay is in proper working order.

7.1.1 Instantaneous Overcurrent Unit (I)

- a. Contact Gap: The gap between the stationary and moving contacts with the relay in the de-energized position should be approximately .020".
- b. Minimum Trip Current: The normally-closed contact of the directional unit should be blocked open when checking the pick-up of the overcurrent unit.

The pick-up of the overcurrent unit can be

checked by inserting the tap screw in the desired tap hole and applying rated tap value current. The contact should close within 5% of tap value current.

7.1.2 Directional Unit (D)

- a. Contact Gap: The gap between the stationary contact and moving contact with the relay in the deenergized position should be approximately .020".
- b. Sensitivity: The respective directional units should trip with value of energization and phase angle relationship as indicated in Table 1 (page 10).
- c. Spurious Torque Adjustments: There should be no spurious closing torques when the operating circuits are energized per Table 2 (page 11) with the polarizing circuits short circuited for the voltage polarized units and open-circuited for the current polarized units.

7.1.3 Time Overcurrent Unit (CO)

Contacts

The index mark on the movement frame will coincide with the "0" mark on the time dial when the stationary contact has moved through approximately one-half of its normal deflection. Therefore, with the stationary contact resting against the backstop, the index mark is offset to the right of the "0" mark by approximately .020". The placement of the various time dial positions in line with the index mark will give operating times as shown on the respective time-current curves.

Minimum Trip Current

Set the time dial to position 6 with the auxiliary switch contacts blocked closed, alternately apply tap value current plus 3% and tap value current minus 3%. The moving contact should leave the backstop at tap value current plus 3% and should return to the backstop at tap value current minus 3%.

Time Curve

Table 3 (page 11) shows the time curve calibration points for the various types of relays. With the time dial set to the indicated position, apply the currents specified by Table 3 (e.g. for the CO-2, 3 and 20 times tap value current) and measure the operating time of the relay. The operating times should equal those of Table 3 plus or minus 5 percent.

7.1.4 Indicating Contactor Switches (ICS/I) and (ICS/T)

- a. Close the contacts of the CO and pass sufficient dc current through the trip circuit to close the contact of (ICS/T). This value of current should not be greater than the particular (ICS/T) tap setting being used. The operation indicator target should drop freely, bring the letter "T" into view.
- b. Close the contacts of the instantaneous overcurrent unit (I) and the directional unit (D). Pass sufficient dc current through the trip circuit to close the contacts of (ICS/I). This value of current should not be greater than the particular (ICS/I) tap setting being used. The operation indicator target should drop freely, bringing the letter "I" into view.

7.2 ROUTINE MAINTENANCE

All relays should be inspected periodically and the time of operation should be checked at least once every year or at such other time intervals as may be dictated by experience to be suitable to the particular application. The use of phantom loads, in testing induction-type relays, should be avoided, since the resulting distorted current waveform will produce error in timing.

All contacts should be periodically cleaned. A contact burnisher #182A836H01 is recommended for this purpose. The use of abrasive material for cleaning contacts is not recommended, because of the danger of embedding small particles in the face of the soft silver and thus impairing the contact.

7.3 CALIBRATION

Use the following procedure for calibrating the relay if the relay has been taken apart for repairs or the adjustments have been disturbed. This procedure should not be used unless it is apparent that the relay is not in proper working order. (See Acceptance Check, page 6.)

7.4 INSTANTANEOUS OVERCURRENT UNIT (I)

- a. The upper pin bearing should be screwed down until there is approximately .025 clearance between it and the top of shaft bearing. The upper pin bearing should then be securely locked in position with the lock nut. The lower bearing position is fixed and cannot be adjusted!

b. The contact gap adjustment for the overcurrent unit is made with the moving contact in the reset position i.e., against the right side of the bridge. Move in the left-hand stationary contact until it just touches the moving contact then back off the stationary contact 2/3 of one turn for a gap of approximately .020". The clamp holding the stationary contact housing need not be loosened for the adjustment since the clamp utilizes a spring-type action in holding the stationary contact in position.

c. The sensitivity adjustment is made by varying the tension of the spiral spring attached to the moving element assembly. The spring is adjusted by placing a screwdriver or similar tool into one of the notches located on the periphery of the of the spring adjuster and rotating it. The spring adjuster is located on the underside of the bridge and is held in place by a spring type clamp that does not have to be loosened prior to making the necessary adjustments.

Before applying current, block open the normally-closed contact of the directional unit insert the tap screw in the minimum value tap setting and adjust the spring such that the contacts will close as indicated by a neon lamp in the contact circuit when energized with the required current. The pick up of the overcurrent unit with the tap screw in any other tap should be within 5% of tap value.

If adjustment of pick-up current in-between tap settings is desired insert the tap screw in the next lowest tap setting and adjust the spring as described. It should be noted that this adjustment results in a slightly different time characteristic curve and burden.

7.4.1 Directional Unit (D)

In the type IRP and IRC relays the directional unit is the lower cylinder unit. In the type IRD the directional units are the lower and middle cylinder units.

- a. The upper bearing screw should be screwed down until there is approximately .025 clearance between it and the top of the shaft bearing. The upper pin bearing should then be securely locked in position with the lock nut.
- b. Contact gap adjustment for the directional unit is made with the moving contact in the reset position, i.e., against the right side of the bridge.

Advance the right hand stationary contact until the contacts just close. Then advance the stationary contact an additional one-half turn.

Now move in the left-hand stationary contact until it just touches the moving contact. Then back off the stationary contact 3/4 of one turn for a contact gap of .020" to .024". The clamp holding the stationary contact housing need not be loosened for the adjustment since the clamp utilizes a spring-type action in holding the stationary contact in position.

- c. Insert tap screw of overcurrent unit in highest tap. The sensitivity adjustment is made by varying the tension of the spiral attached to the moving element assembly. The spring is adjusted by placing a screwdriver or similar tool into one of the notches located on the periphery of the spring adjuster and rotating it. The spring adjuster is located on the underside of the bridge and is held in place by a spring type clamp that does not have to be loosened prior to making the necessary adjustments. Set red mark on core to left side of cylinder unit and adjust spring to just reset.

The spring is to be adjusted such that the contacts will close as indicated by a neon lamp in the contact circuit when energized with the required current and voltage as shown in Table 1 (page 10). This table indicates that the spring can be adjusted when the phase angle relationship between the operating circuit and the polarizing circuit is at the maximum torque angle or when the circuit relationship has the operating and polarizing circuits in phase.

- d. The magnetic plugs are used to reverse any unwanted spurious torques that may be present when the relay is energized on current or voltage alone.

The reversing of the spurious torques is accomplished by using the adjusting plugs in the following manner:

1. Voltage circuit terminals on the voltage polarized relays (IRP and IRD voltage polarized unit) are short-circuited.
2. The polarizing circuits of the current polarized relays (IRC and IRD current polarized unit) are open-circuited.

Upon completion of steps 1 or 2 above, apply 5 amps and gradually increase to 80 amps. Note, high current to be applied only momentarily.

Plug adjustment is then made per Table 2 (page 11) such that the spurious torques are reversed. The plugs are held in position by upper and lower plug clips. These clips need not be disturbed in any manner when making the necessary adjustment.

The magnetic plug adjustment may be utilized to positively close the contacts on current alone. This may be desired on some installations in order to insure that the relay will always trip the breaker on zero potential.

- e. The core adjustment is used to eliminate any unwanted spurious torques that may be present when the relay is energized with voltage alone.

Apply 120V AC to terminals 4 (+) and 5 for IRD and terminals 6 (+) and 7 for IRP and adjust core so that contacts just open.

7.4.2 Time Overcurrent Unit (CO)

Contacts

The index mark on the movement frame will coincide with the "0" mark on the time dial when the stationary contact has moved through approximately one-half of its normal deflection. Therefore, with the stationary contact resting against the backstop, the index mark is offset to the right of the "0" mark by approximately .020". The placement of the various time dial positions in line with the index mark will give operating times as shown on the respective time-current curves.

Minimum trip Current

The adjustment of the spring tension in setting the minimum trip current value of the relay is most conveniently made with the damping magnet removed.

With the time dial set on "0", wind up the spiral spring by means of the spring adjuster until approximately 6-3/4 convolutions show.

Set the relay on the minimum tap setting, the time dial to position 6.

With auxiliary switch (Aux) contacts blocked closed, adjust the control spring tension so that the moving contact will leave the backstop at tap value current

+1.0% and will return to the backstop at tap value current -1.0%.

Time Curve Calibration

Install the permanent magnet.

Apply the indicated current per Table 3 (page 11) for permanent magnet adjustment (e.g. IRP-8, 2 times tap value) and measure the operating time. Adjust the permanent magnet keeper until the operating time corresponds to the value of Table 3.

Apply the indicated current per Table 3 for the electromagnet plug adjustment (e.g. IRP-8, 20 times tap value) and measure the operating time. Adjust the proper plug until the operating time corresponds to the value in Table 3. (Withdrawing the left hand plug, front view increases the operating time and withdrawing the right hand plug, front view, decreases the time.) In adjusting the plugs, one plug should be screwed in completely and the other plug run in or out until the proper operating time has been obtained.

Recheck the permanent magnet adjustment. If the operating time for this calibration point has changed, readjust the permanent magnet and then recheck the electromagnet plug adjustment.

7.5 INDICATING CONTACTOR SWITCHES (ICS/I) AND (ICS/T)

For proper contact adjustment, insert a .030" feeler gauge between the core pin and the armature. Hold the armature closed against the core pin and gauge and adjust the stationary contacts such that they just make with the moving contact. Both stationary contacts should make at approximately the same time. The contact follow will be approximately 1/64" to 3/64".

Close the contacts of the CO and pass sufficient dc current through the trip circuit to close the contacts of the (ICS/T). This value of current should not be greater than the particular (ICS/T) tap setting being used. The operation indicator target should drop freely bringing the letter "T" into view.

Close contacts of instantaneous overcurrent unit (I) and directional unit (D). Pass sufficient dc current through the trip circuit to close contacts of the (ICS/I). This value of current should not be greater than the particular (ICS/I) tap setting being used. The opera-

tion indicator target should drop freely bringing the letter "I" into view.

7.5.1 Auxiliary Switch (CS-1 or TR-1)

Adjust the stationary core of the CS-1 switch for a clearance between the stationary core and the moving core when the switch is picked up. This can be done by turning the relay upside-down. Then screw up the core screw until the moving core starts rotating. Now back off the core screw until the moving core stops rotating. This indicates the points where the play in the assembly is taken up, and where the moving core just separates from the stationary core screw. Back off the core screw approximately one turn and lock in place. This prevents the moving core from striking and sticking to the stationary core because of residual magnetism. Adjust the contact

clearance for 3/64" by means of the two small nuts on either side of the Micarta disc. **The TR-1 switch does not require adjustment.**

Connect lead (A) to proper terminal per Figure 26 (page 40). Block directional unit (D) contacts close and energize trip circuit with rated voltage. Contacts of auxiliary switch (CS-1 or TR-1) should make as indicated by a neon lamp in the contact circuit.

8.0 RENEWAL PARTS

Repair work can be done most satisfactorily at the factory. However, interchangeable parts can be furnished to the customers who are equipped for doing repair work. When ordering parts, always give the complete nameplate data.

**TABLE 1
DIRECTIONAL UNIT SENSITIVITY**

RELAY TYPE	AMPERE RATING OF TIME-OVERCURRENT UNIT	VALUES FOR [†] MIN. PICKUP		PHASE ANGLE RELATIONSHIP
		VOLTS	AMPERES	
IRP (Voltage IRD Unit)	.5-2.5 2-6	1 1	2.0 4.0	I lagging V by 60° ^{††} I in-phase with V
	4-12	1 1	4.0 8.0	I lagging V by 60° ^{††} I in-phase with V
IRC (Current IRD Unit) ^Δ	.5-2.5 2-6		0.5 .57	I _o leading I _p by 40° ^{††} In-phase
	4-12		1.0 1.3	I _o leading I _p by 40° ^{††} In-phase

[†] The energization quantities are input quantities at the relay terminals.

^{††} Maximum torque angle.

^Δ When normal system conditions limit the current to less twice pickup, performance may be by selecting a higher current ct tap to energize the polarizing circuit.

TABLE 2
DIRECTIONAL UNIT CALIBRATION †

RELAY RATING	CURRENT AMPERES	BOTH PLUGS IN CONDITION	ADJUSTMENT
0.5-2.5 Amps 2-6 Amps	5 - 80	Spurious Torque in contact closing direction (left front view).	Right (front-view) plug screwed out until Spurious Torque is reversed.
4-12 Amps	5 - 80		
0.5-2.5 Amps 2-6 Amps	5 - 80	Spurious Torque in contact opening direction (right front view, contacts remain open).	Left (front view) plug screwed out until Spurious Torque is in contact closing direction. Then the plug is screwed in until Spurious Torque is reversed.
4-12 Amps	5 - 80		

† Short circuit the voltage polarizing at the relay terminals before making the above adjustment.

TABLE 3
TIME CURVE CALIBRATION DATA – 60 HERTZ

PERMANENT MAGNET ADJUSTMENT			ELECTROMAGNET PLUGS		
TIME OVERCURRENT UNIT TYPE	TIME DIAL POSITION	CURRENT (MULTIPLES OF TAP VALUE)	OPERATING TIME SECONDS	CURRENT (MULTIPLES OF TAP VALUE)	OPERATING TIME SECONDS
2	6	3	0.57	20	0.22
5	6	2	37.80	10	14.30
6	6	2	2.46	20	1.19
7	6	2	4.27	20	1.11
8	6	2	13.35	20	1.11
9	6	2	8.87	20	0.65
11	6	2	11.27	20	0.24

RATINGS OF OVERCURRENT UNIT

RANGE	CONTINUOUS RATING (AMPERES)	ONE SECOND RATING (AMPERES) †
.5-2	5	100
1-4	8	140
2-8	8	140
4-16	10	200
10-40	10	200
20-80	10	200

† Thermal capacities for short times other than one second may be calculated on the basis of time being inversely proportional to the square of the current.

ENERGY REQUIREMENTS
INSTANTANEOUS OVERCURRENT UNIT OPERATING CIRCUIT- 60 HERTZ

AMPERE RANGE	TAP	VA AT TAP VALUE	ϕ P.F. ANGLE	VA AT 5 AMPS	ϕ P.F. ANGLE
.5-2	.5	.37	39	24.	46
	.75	.38	36	13.	37
	1.	.39	35	8.5	34
	1.25	.41	34	6.0	32
	1.5	.43	32	4.6	31
	2.	.45	30	2.9	28
1-4	1.	.41	36	9.0	36
	1.5	.44	32	5.0	32
	2.	.47	30	3.0	29
	2.5	.50	28	2.1	27
	3.	.53	26	1.5	26
	4.	.59	24	0.93	24
2-8	2.	1.1	49	6.5	48
	3.	1.2	43	3.3	42
	4.	1.3	38	2.1	37
	5.	1.4	35	1.4	35
	6.	1.5	33	1.1	33
	8.	1.8	29	0.7	29
4-16	4.	1.5	51	2.4	51
	6.	1.7	45	1.2	45
	8.	1.8	40	0.7	40
	9.	1.9	38	0.6	38
	12.	2.2	34	0.37	34
	16.	2.5	30	0.24	31
10-40	10.	1.7	28	0.43	28
	15.	2.4	21	0.27	21
	20.	3.1	16	0.20	17
	24.	3.6	15	0.15	15
	30.	4.2	12	0.11	13
	40.	4.9	11	0.08	12
20-80	20.	6.6	31	0.40	31
	30.	9.3	24	0.25	24
	40.	12.0	20	0.18	20
	48.	13.5	18	0.14	18
	60.	15.9	16	0.10	16
	80.	19.2	15	0.07	15

ϕ Degrees current lags voltages.

ENERGY REQUIREMENTS – 60 HERTZ
DIRECTIONAL UNIT OPERATING CIRCUIT BURDEN

Relay Type	Range AMPS	Continuous Rating (Amperes)	One Second Rating [†] (Amperes)	Power Factor Angle ϕ	VOLT AMPERES			
					At Minimum Tap Value Current	At 3 Times Minimum Tap Value Current	At 10 Times Minimum Tap Value Current	At 20 Times Minimum Tap Value Current
IRC	0.5-2.5	--	230	44.0	0.033	0.30	3.3	14.2
	2-6	--	230	42.5	0.58	5.28	58.0	240.0
	4-12	12	280	31.8	0.64	6.12	70.0	272.0
IRP	0.5-2.5	10	230	34.5	0.03	0.23	2.8	11.5
	2-6	10	230	34.5	0.44	4.08	48.0	182.0
	4-12	12	280	25.0	0.48	4.62	53.6	216.0
IRD	0.5-2.5	10	230	45.0	0.07	0.59	6.6	26.0
	2-6	10	230	45.0	1.04	9.9	106.0	420.0
	4-12	12	280	32.4	1.16	10.8	121.2	472.0

ϕ Degrees current lags voltages at tap value current.

[†] Thermal capacities for short times other than one second may be calculated on the basis of time being inversely proportional to the square of the current.

ENERGY REQUIREMENTS – 60 HERTZ
DIRECTIONAL UNIT POLARIZING CIRCUIT BURDEN

RELAY TYPE	RATING	VOLT AMPERES Δ	POWER FACTOR ANGLE ϕ
IRC	230 Amperes [†]	1.45	8° Lag
IRP	208 Volts ^{††}	11.2	28° Lag
IRD Current Unit	230 Amperes [†]	1.45	8° Lag
IRD Current Unit	208 Volts ^{††}	11.2	28° Lag

ϕ Degrees current leads or lags voltage at 120 volts on voltage polarized units and 5 amperes on current polarized units.

Δ Burden of voltage polarized units taken at 120 volts. Burden of current polarized units taken at 5 amperes.

[†] One second rating.

^{††} 30 second rating. The 10 second rating is 345 volts. The continuous rating is 120 volts.

ENERGY REQUIREMENTS

TIME OVERCURRENT UNITS: TYPE IRD-2, IRC-2, IRP-2,

Ampere Range	TAP	Continuous Rating (Amperes)	One Second Rating [†] (Amperes)	Power Factor Angle ϕ	VOLT AMPERES [‡]			
					At Minimum Tap Value Current	At 3 Times Minimum Tap Value Current	At 10 Times Minimum Tap Value Current	At 20 Times Minimum Tap Value Current
0.5/2.5	0.5	.91	28	58	4.8	39.6	256	790
	0.6	0.96	28	57	4.9	39.8	270	815
	0.8	1.18	28	53	5.0	42.7	308	1024
	1.0	1.37	28	50	5.3	45.4	348	1220
	1.5	1.95	28	40	6.2	54.4	435	1740
	2.0	2.24	28	36	7.2	65.4	580	2280
	2.5	2.50	28	28	29	7.9	73.6	700
2/6	2.0	3.01	110	59	5.04	38.7	262	800
	2.5	4.0	110	55	5.13	39.8	280	920
	3.0	4.4	110	51	5.37	42.2	312	1008
	3.5	4.8	110	47	5.53	44.0	329	1120
	4.0	5.2	110	45	5.72	46.0	360	1216
	5.0	5.6	110	41	5.90	50.3	420	1500
	6.0	6.0	110	37	6.54	54.9	474	1800
4/12	4.0	7.3	230	65	4.92	39.1	268	848
	5.0	8.0	230	50	5.20	42.0	305	1020
	6.0	8.8	230	47	5.34	44.1	330	1128
	7.0	9.6	230	46	5.53	45.8	364	1260
	8.0	10.4	230	43	5.86	49.9	400	1408
	10.0	11.2	230	37	6.6	55.5	470	1720
	12.0	12.0	230	34	7.00	62.3	528	2064

[†] Thermal capacities for short times other than one second may be calculated on the basis of time being inversely proportional to the square of the current.

ϕ Degrees current lags voltage at tap value current.

[‡] Voltages taken with high impedance type voltmeter

ENERGY REQUIREMENTS

TIME OVERCURRENT UNITS: IRD-5, IRC-5, IRP-5
IRD-6, IRC-6, IRP-6

Ampere Tap Value Range	TAP	Continuous Rating (Amperes)	One Second Rating † (Amperes)	Power Factor Angle ϕ	VOLT AMPERES ‡			
					At Tap Value Current	At 3 Times Tap Value Current	At 10 Times Tap Value Current	At 20 Times Tap Value Current
0.5/2.5	0.5	2.7	88	69	3.92	20.6	103	270
	0.6	3.1	88	68	3.96	20.7	106	288
	0.8	3.7	88	67	3.96	21.0	114	325
	1.0	4.1	88	66	4.07	21.4	122	360
	1.5	5.7	88	62	4.19	23.2	147	462
	2.0	6.8	88	60	4.30	24.9	168	548
	2.5	7.7	88	88	58	4.37	26.2	180
2/6	2	8	230	67	3.88	21.0	110	308
	2.5	8.8	230	66	3.90	21.6	118	342
	3	9.7	230	64	3.93	22.1	126	381
	3.5	10.4	230	63	4.09	23.1	136	417
	4	11.2	230	62	4.12	23.5	144	448
	5	12.5	230	59	4.20	24.8	162	540
	6	13.7	230	230	57	4.38	26.5	183
4/12	4	16	460	65	4.00	22.4	126	376
	5	18.8	460	63	4.15	23.7	143	450
	6	19.3	460	61	4.32	25.3	162	531
	7	20.8	460	59	4.35	26.4	183	611
	8	22.5	460	56	4.40	27.8	204	699
	10	25	460	53	4.60	30.1	247	880
	12	28	460	460	47	4.92	35.6	288

† Thermal capacities for short times other than one second may be calculated on the basis of time being inversely proportional to the square of the current.

ϕ Degrees current lags voltage at tap value current.

‡ Voltages taken with high impedance type voltmeter

ENERGY REQUIREMENTS

TIME OVERCURRENT UNITS: IRD-7, IRC-7, IRP-7

Ampere Tap Value Range	TAP	Continuous Rating (Amperes)	One Second Rating † (Amperes)	Power Factor Angle ϕ	VOLT AMPERES ‡			
					At Tap Value Current	At 3 Times Tap Value Current	At 10 Times Tap Value Current	At 20 Times Tap Value Current
0.5/2.5	0.5	2.7	88	68	3.88	20.7	103	278
	0.6	3.1	88	67	3.93	20.9	107	288
	0.8	3.7	88	66	3.93	21.1	114	320
	1.0	4.1	88	64	4.00	21.6	122	356
	1.5	5.7	88	61	4.08	22.9	148	459
	2.0	6.8	88	58	4.24	24.8	174	552
	2.5	7.7	88	88	56	4.38	25.9	185
2/6	2	8	230	66	4.06	21.3	111	306
	2.5	8.8	230	63	4.07	21.8	120	342
	3	9.7	230	63	4.14	22.5	129	366
	3.5	10.4	230	62	4.34	23.4	141	413
	4	11.2	230	61	4.34	23.8	149	448
	5	12.5	230	59	4.40	23.2	163	530
	6	13.7	230	230	58	4.62	27.0	183
4/12	4	16	460	64	4.24	22.8	129	392
	5	18.8	460	61	4.30	24.2	149	460
	6	19.3	460	60	4.62	25.9	168	540
	7	20.8	460	58	4.69	27.3	187	626
	8	22.5	460	55	4.80	29.8	211	688
	10	25	460	51	5.20	33.0	260	860
	12	28	460	460	46	5.40	37.5	308

† Thermal capacities for short times other than one second may be calculated on the basis of time being inversely proportional to the square of the current.

ϕ Degrees current lags voltage at tap value current.

‡ Voltages taken with high impedance type voltmeter

ENERGY REQUIREMENTS

TIME OVERCURRENT UNITS: IRD-8, IRC-8, IRP-8
IRD-9, IRC-9, IRP-9

Ampere Tap Value Range	TAP	Continuous Rating (Amperes)	One Second Rating † (Amperes)	Power Factor Angle ϕ	VOLT AMPERES ‡			
					At Tap Value Current	At 3 Times Tap Value Current	At 10 Times Tap Value Current	At 20 Times Tap Value Current
0.5/2.5	0.5	2.7	88	72	2.38	21.0	132	350
	0.6	3.1	88	71	2.38	21.0	134	365
	0.8	3.7	88	69	2.40	21.1	142	400
	1.0	4.1	88	67	2.42	21.2	150	440
	1.5	5.7	88	62	2.51	22.0	170	530
	2.0	6.8	88	57	2.65	23.5	200	675
	2.5	7.7	88	88	53	2.74	24.8	228
2/6	2	8	230	70	2.38	21.0	136	360
	2.5	8.8	230	66	2.40	21.1	142	395
	3	9.7	230	64	2.42	21.5	149	430
	3.5	10.4	230	62	2.48	22.0	157	470
	4	11.2	230	60	2.53	22.7	164	500
	5	12.5	230	58	2.64	24.0	180	580
	6	13.7	230	56	2.75	25.2	198	660
4/12	4	16	460	68	2.38	21.3	146	420
	5	18.8	460	63	2.46	21.8	158	480
	6	19.3	460	60	2.54	22.6	172	550
	7	20.8	460	57	2.62	23.6	190	620
	8	22.5	460	54	2.73	24.8	207	700
	10	25	460	48	3.00	27.8	248	850
	12	28	460	45	3.46	31.4	292	1020

† Thermal capacities for short times other than one second may be calculated on the basis of time being inversely proportional to the square of the current.

ϕ Degrees current lags voltage at tap value current.

‡ Voltages taken with high impedance type voltmeter

ENERGY REQUIREMENTS

TIME OVERCURRENT UNITS: IRD-11, IRC-11, IRP-11

Ampere Tap Value Range	TAP	Continuous Rating (Amperes)	One Second Rating † (Amperes)	Power Factor Angle ϕ	VOLT AMPERES ‡			
					At Tap Value Current	At 3 Times Tap Value Current	At 10 Times Tap Value Current	At 20 Times Tap Value Current
0.5/2.5	0.5	1.7	56	36	0.72	6.54	71.8	250
	0.6	1.9	56	34	0.75	6.80	75.0	267
	0.8	2.2	56	30	0.81	7.46	84.0	298
	1.0	2.5	56	27	1.89	8.30	93.1	30
	1.5	3.0	56	22	1.13	10.04	115.5	411
	2.0	3.5	56	17	1.30	11.95	136.3	502
	2.5	3.8	56	16	1.48	13.95	160.0	610
2/6	2	7.0	230	32	0.73	6.30	74.0	264
	2.5	7.8	230	30	0.78	7.00	78.5	285
	3	8.3	230	27	0.83	7.74	84.0	309
	3.5	9.0	230	24	0.88	8.20	89.0	340
	4	10.0	230	23	0.96	9.12	102.0	372
	5	11.0	230	20	1.07	9.80	109.0	430
	6	12.0	230	20	1.23	11.34	129.0	504
4/12	4	14	460	29	0.79	7.08	78.4	296
	5	16	460	25	0.89	8.00	90.0	340
	6	17	460	22	1.02	9.18	101.4	378
	7	18	460	20	1.10	10.00	110.0	454
	8	20	460	18	1.23	11.1	124.8	480
	10	22	460	17	1.32	14.9	131.6	600
	12	26	460	16	1.8	16.3	180.0	720

IRD TIME OVERCURRENT UNIT BURDEN DATA AT HIGH CURRENTS

AMPERE RANGE	.5 - 2.5					
TAP VALUE CURRENT	.5		1.0		2.5	
MULTIPLES OF TAP VALUE CURRENT	40	80	20	40	8	16
VA ††	790	2600	380	1280	60	280
P.F. ANGLE ϕ	46.7°	42°	37°	26.5°	4.8°	4.3°

† Thermal capacities for short times other than one second may be calculated on the basis of time being inversely proportional to the square of the current.

ϕ Degrees current lags voltage at tap value current.

‡ Voltages taken with high impedance type voltmeter

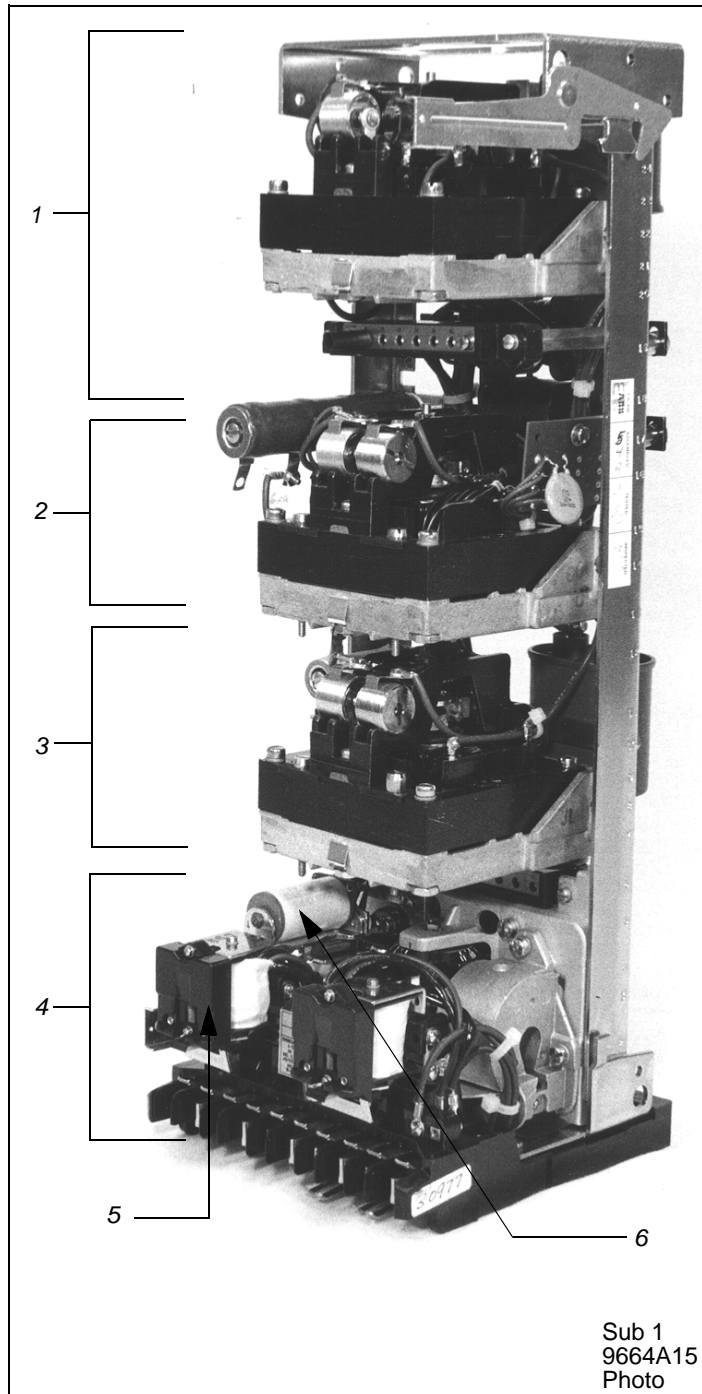

Figure 1: Type IRD Relay Without Case (Front View)

- 1) Instantaneous Overcurrent Unit and Saturating Transformer
- 2) Current Polarized Directional Unit
- 3) Voltage Polarized Directional Unit.
- 4) Time Overcurrent Unit
- 5) Indicating Contactor Switches
- 6) Auxiliary Switch

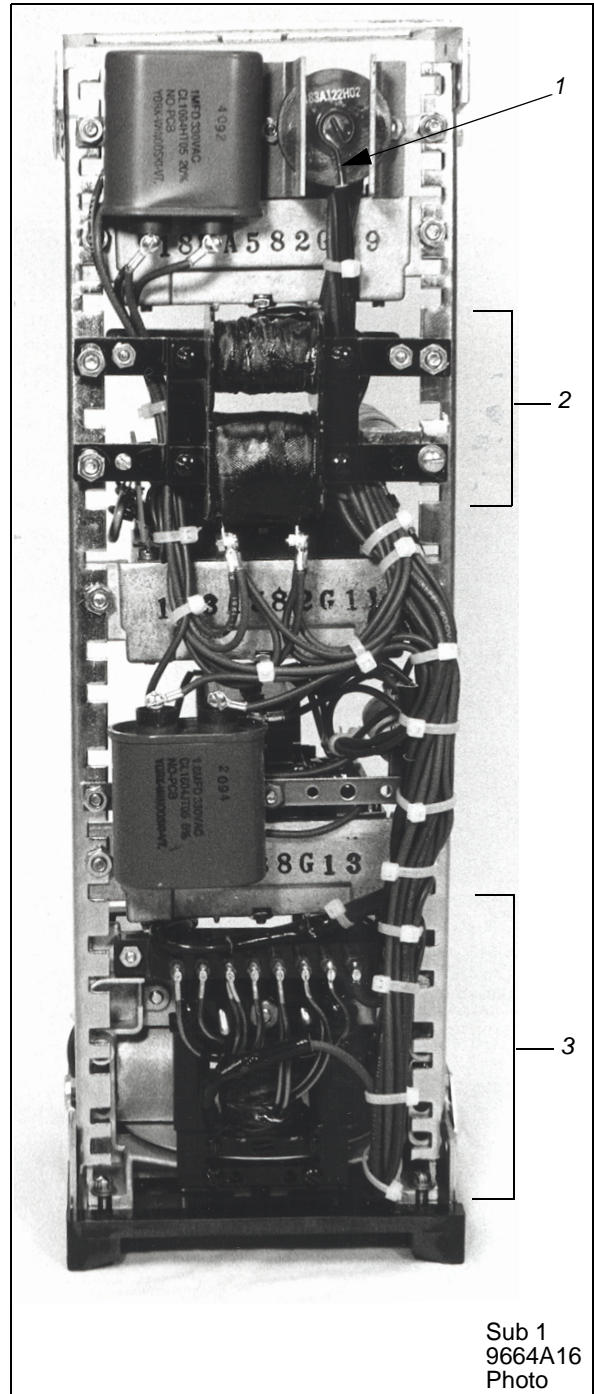

Figure 2: Type IRD Relay without Case (Rear View)

- 1) Varistor
- 2) Saturating Transformer
- 3) "E" type Electromagnet

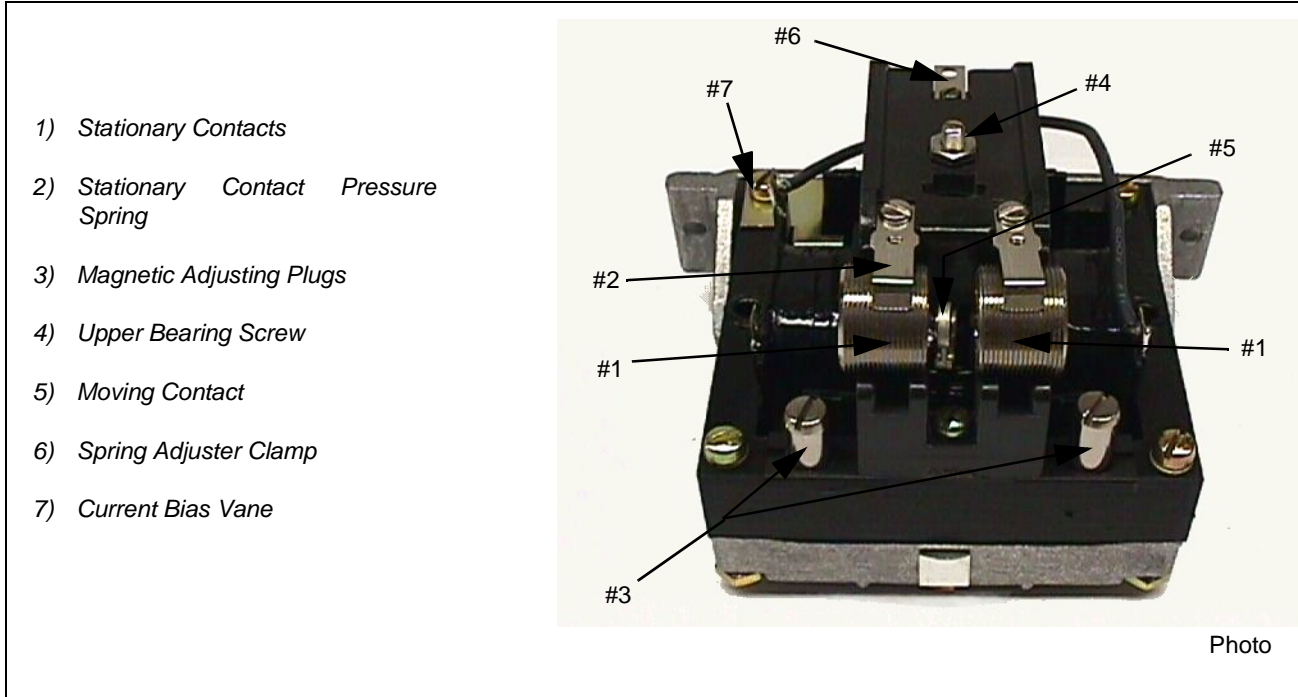

Figure 3: Directional Unit.

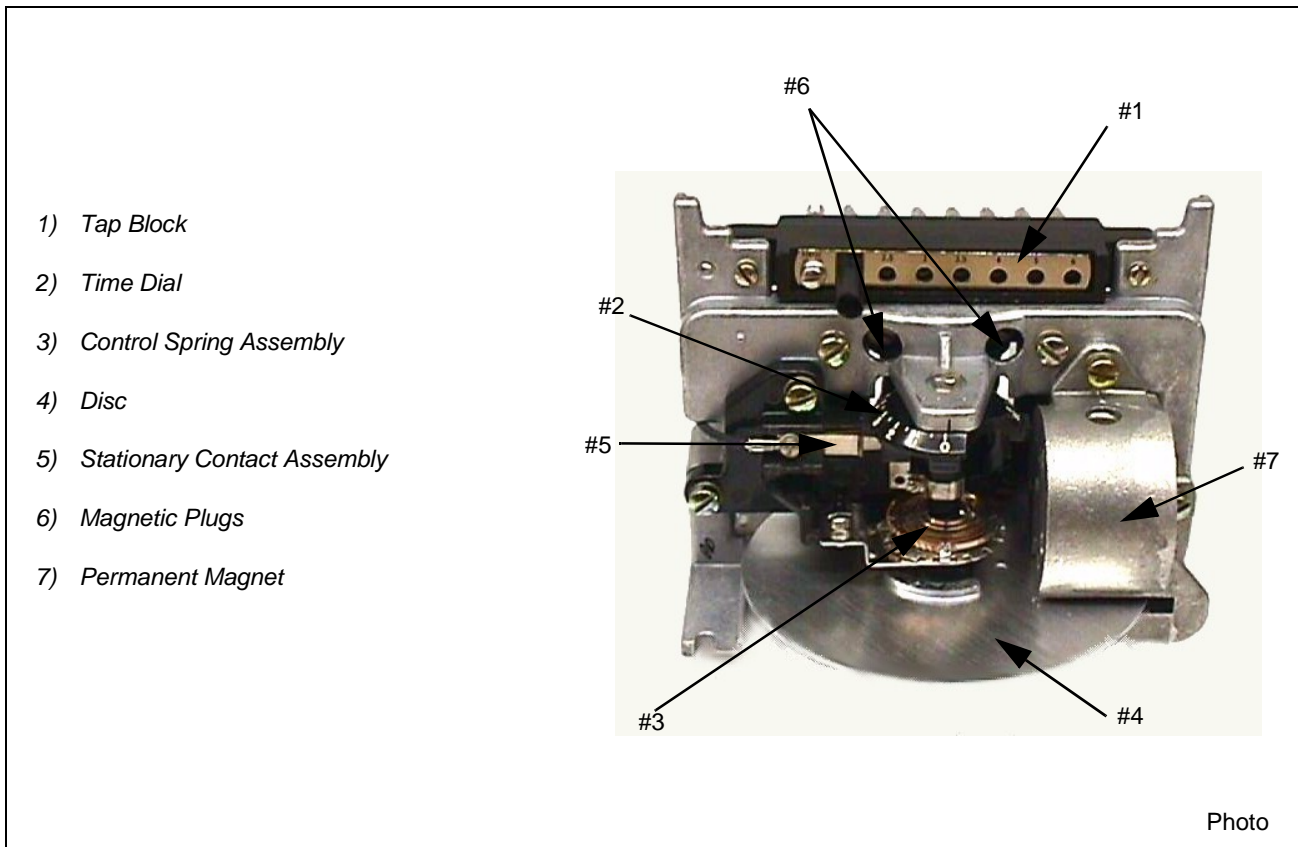

Figure 4: Time Overcurrent Unit.

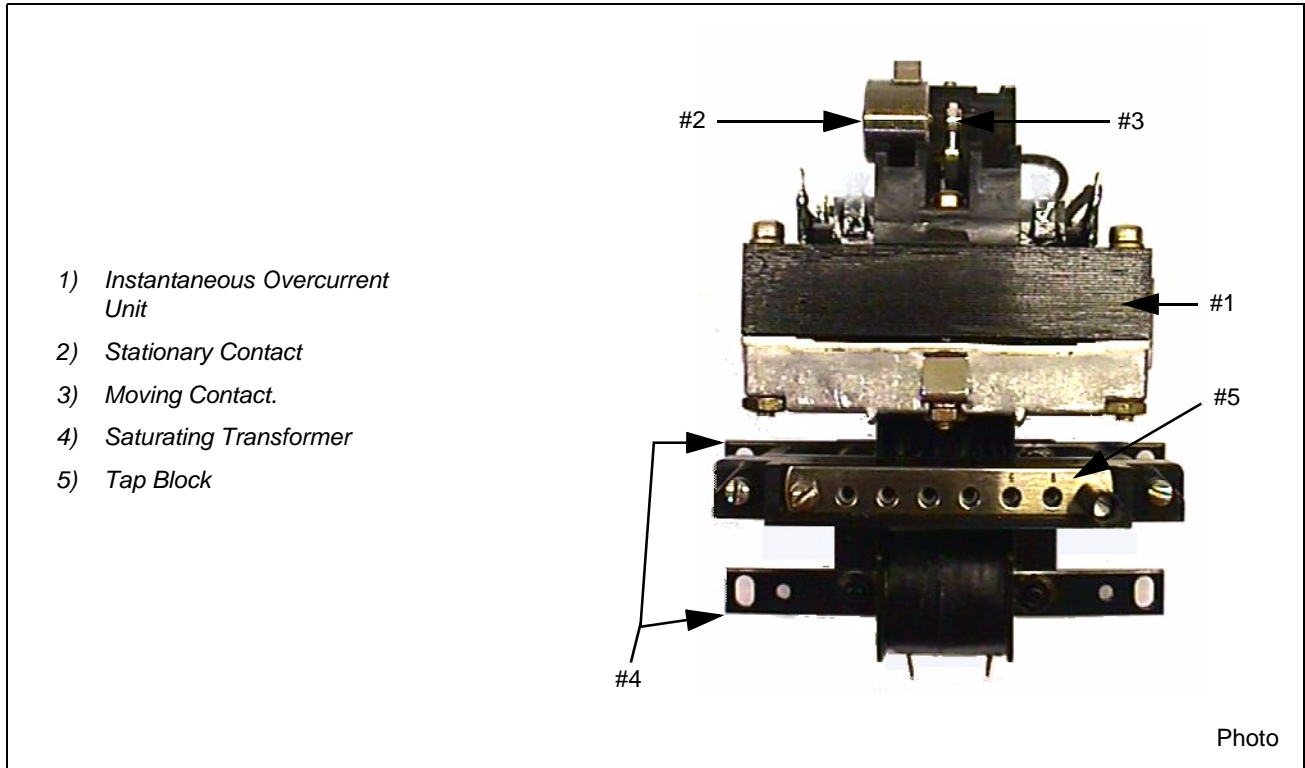

Figure 5: Instantaneous Overcurrent Unit

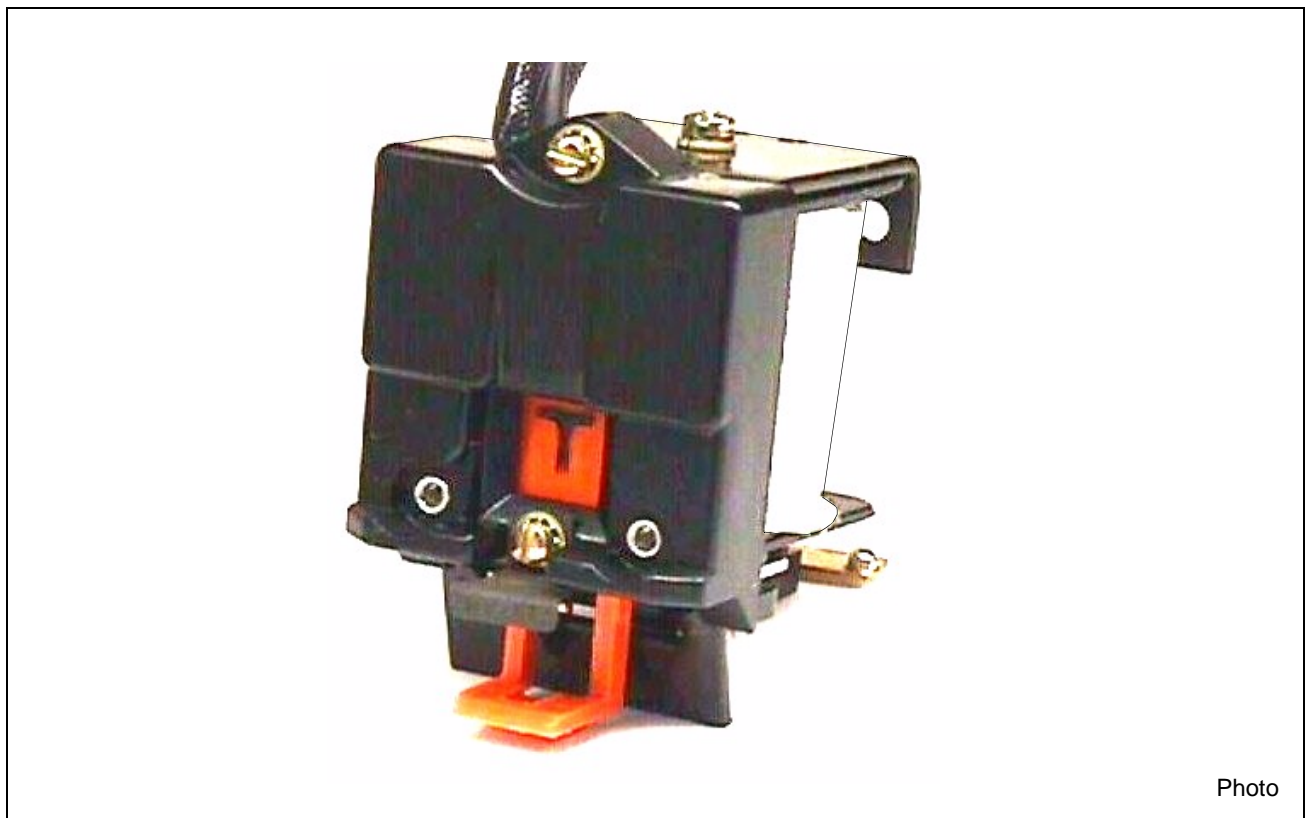
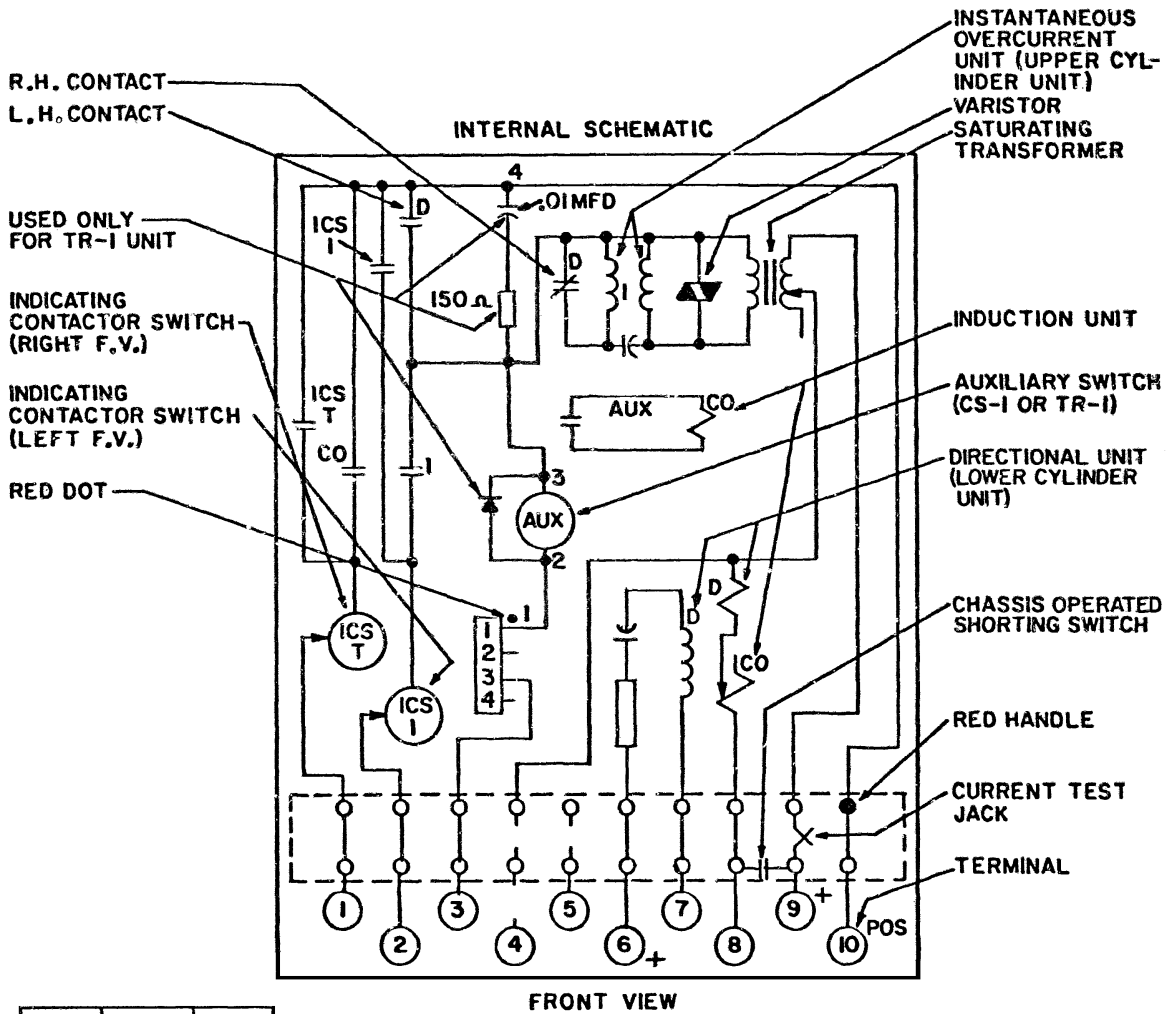

Figure 6: Indicating contactor Switch (ICS)



DC TRIP VOLT.	CONTROL LEAD POS.	CIRCUIT RESIST. VALUE
* 24	1	0
* 48	2	300
* 125	3	2700
* 250	4	6500
** 24	1	0
** 48	2	2200
** 125	3	9300
** 250	4	20800

* = RESISTANCE VALUE WITH CS-1
 ** = RESISTANCE VALUE WITH TR-1
 WITH RELATIVE INSTANTANEOUS POLARITY AS SHOWN, THE DIRECTIONAL UNIT CONTACT CLOSURES TO THE LEFT.

*Sub 9
184A033

Figure 7: internal Schematic of the Type IRP Relay in the Type FT-31 Case

*Denotes change since previous issue

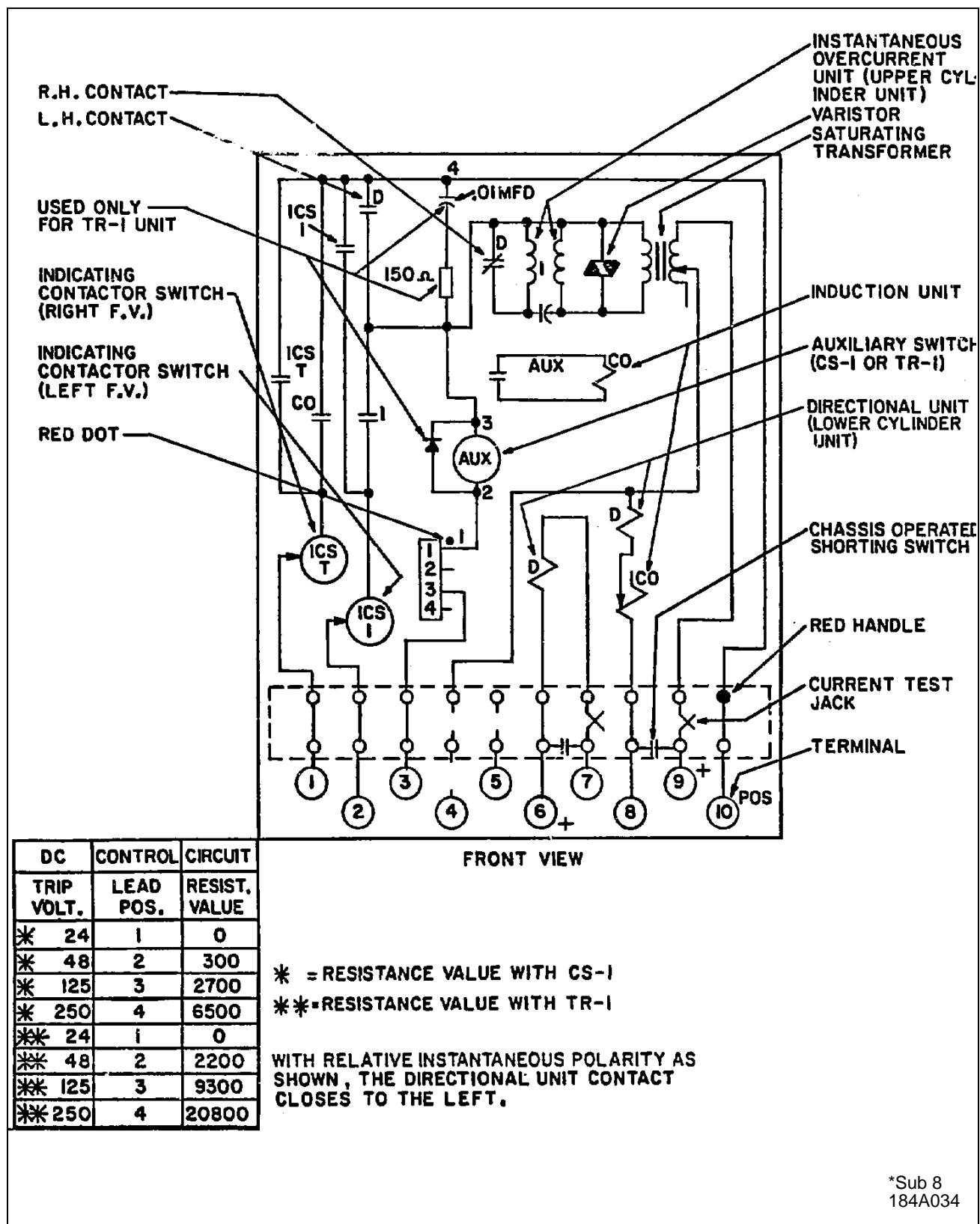

Figure 8: Internal Schematic of the Type IRC Relay in the Type FT-31 Case

*Denotes change since previous issue

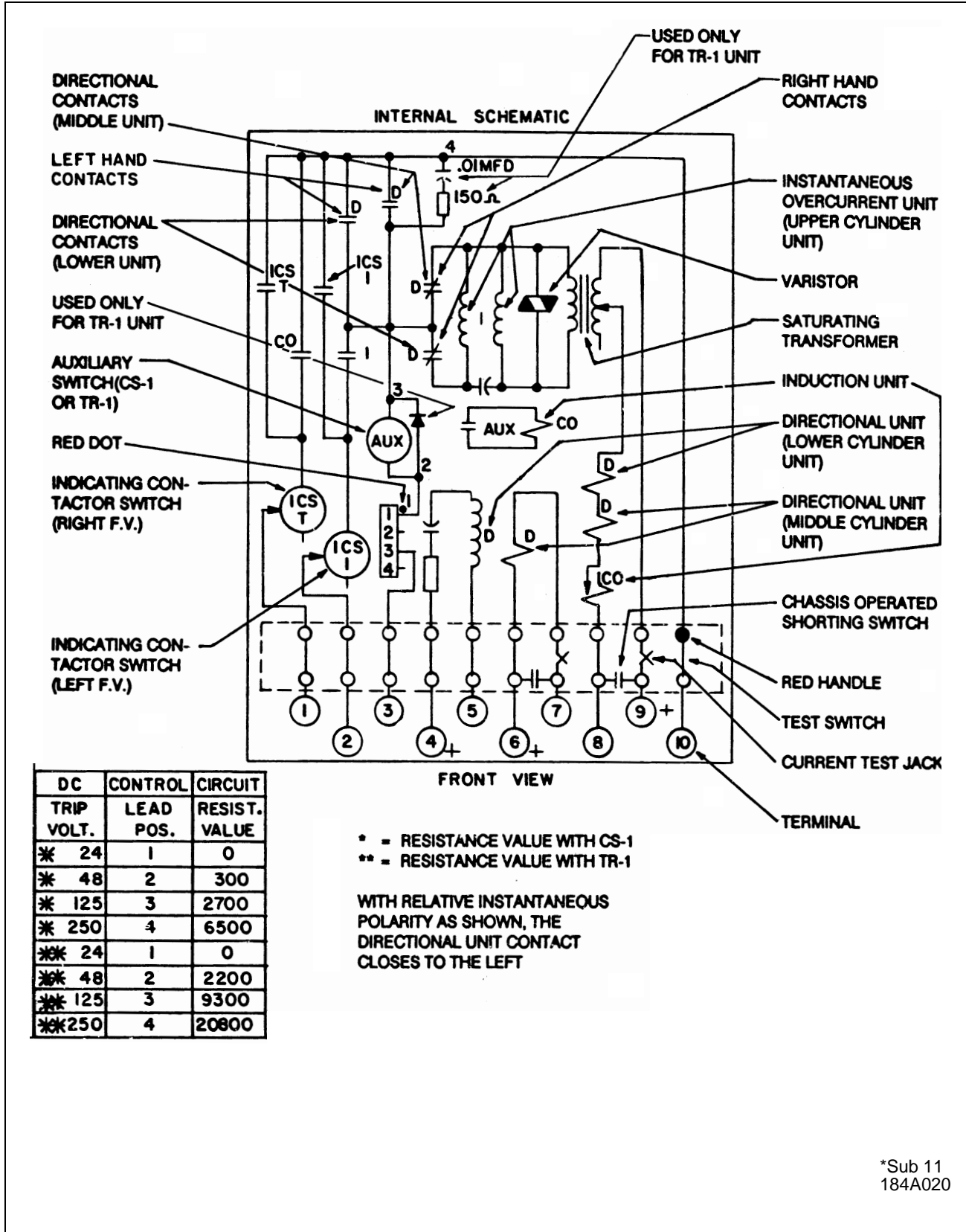

Figure 9: Internal Schematic of the Type IRD Relay in the Type FT-41 Case

*Sub 11
184A020

*Denotes change since previous issue

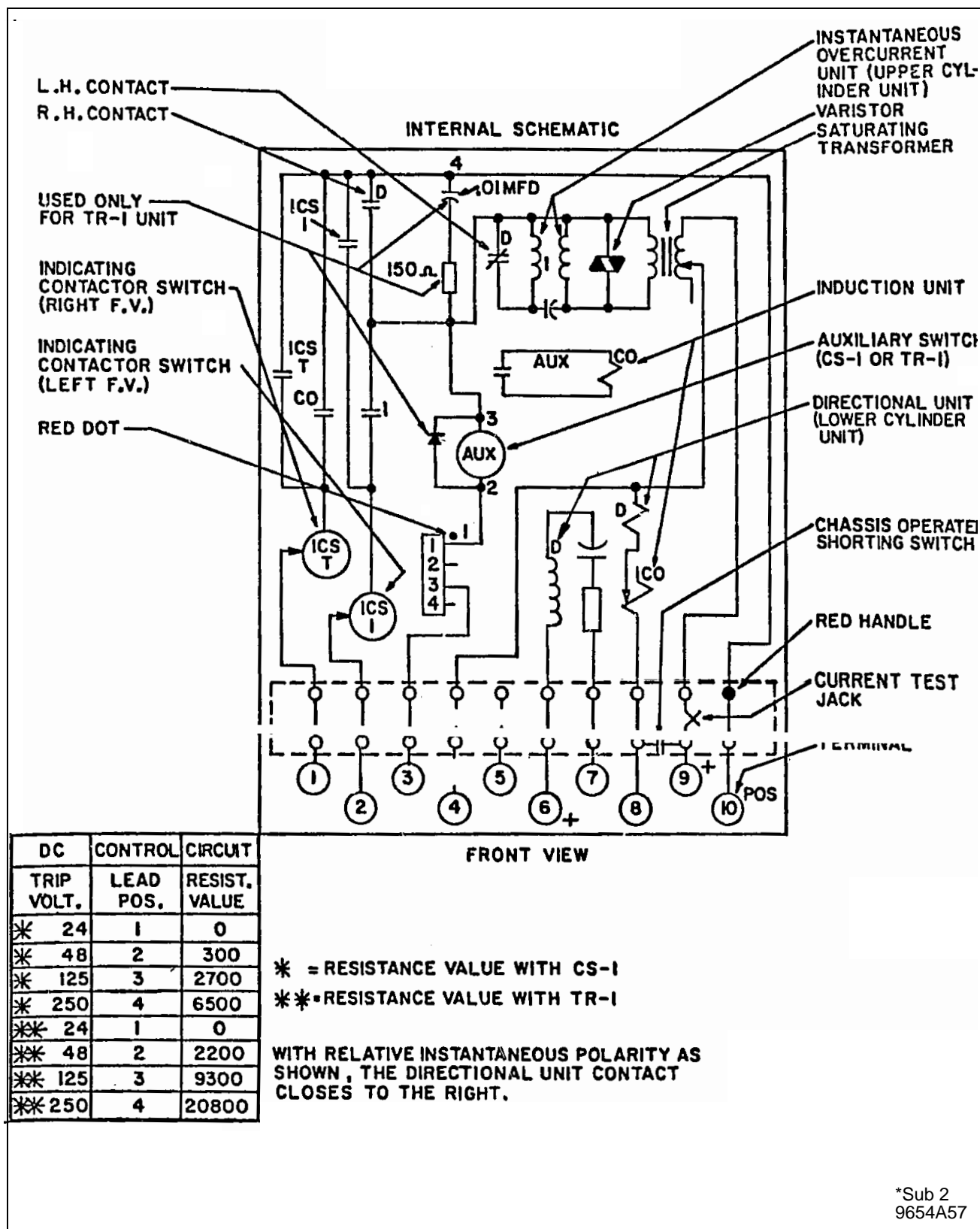

Figure 10: Internal Schematic of the Type IRP Relay, with Field Modified Reversed "D" Contacts, in the Type FT-31 Case.

*Denotes change since previous issue

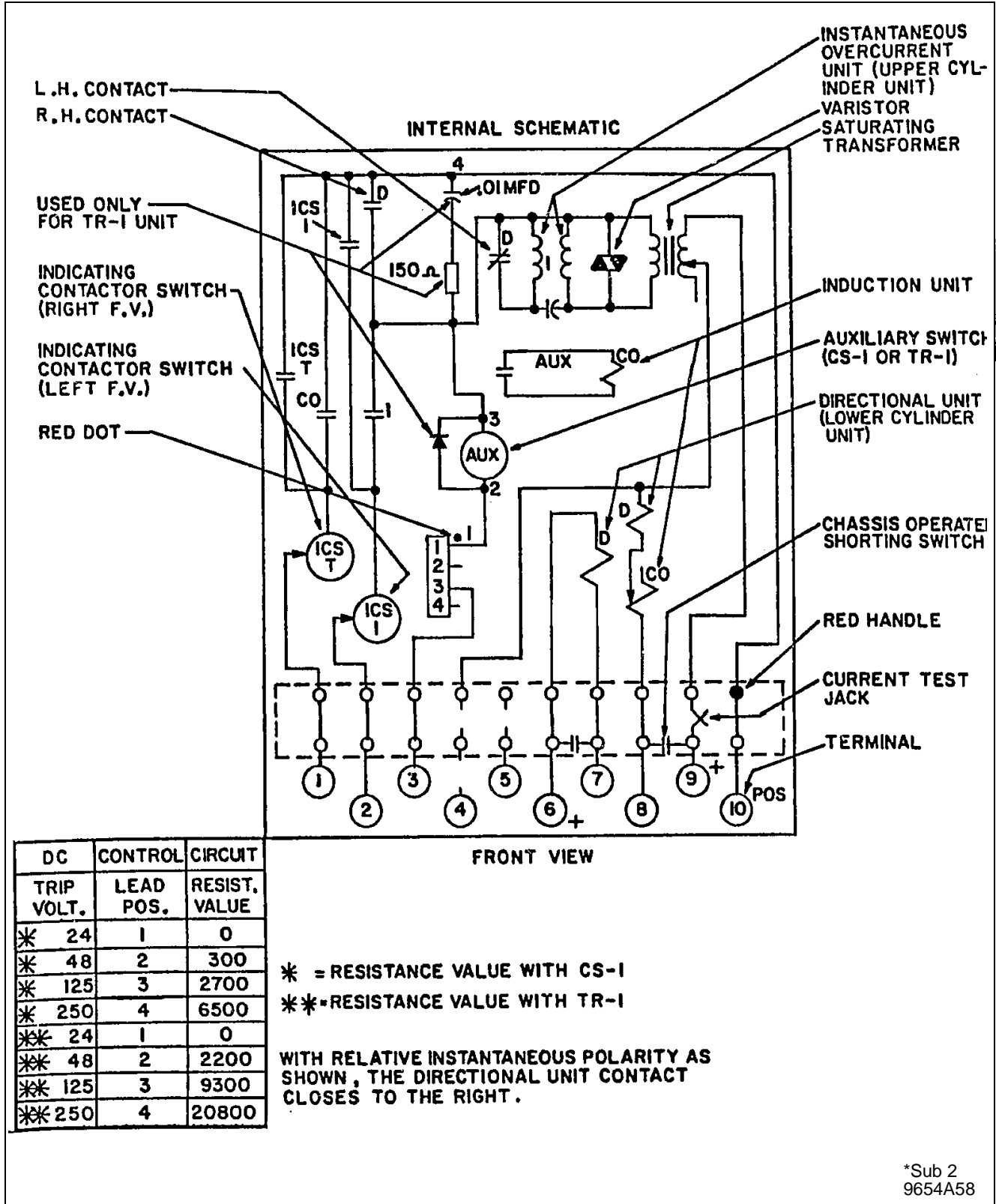

Figure 11: Internal Schematic of the Type IRC Relay, with Field Modified Reversed "D" Contacts, in the Type FT-31 Case

*Denotes change since previous issue

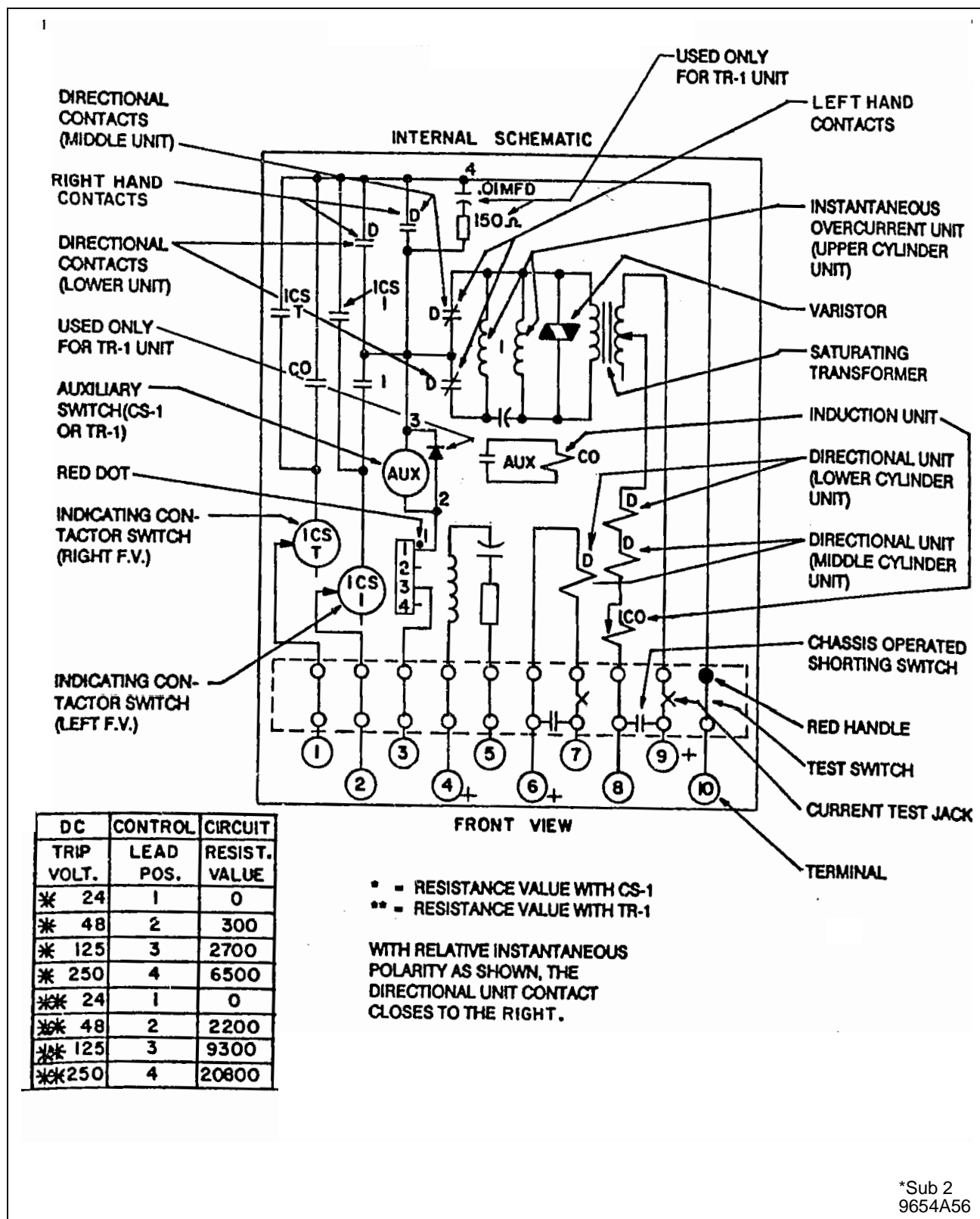

Figure 12: Internal Schematic of the Type IRD Relay, with Field Modified Reversed "D" Contacts, in the Type FT-41 Case

*Denotes change since previous issue

Sub 4
289B508

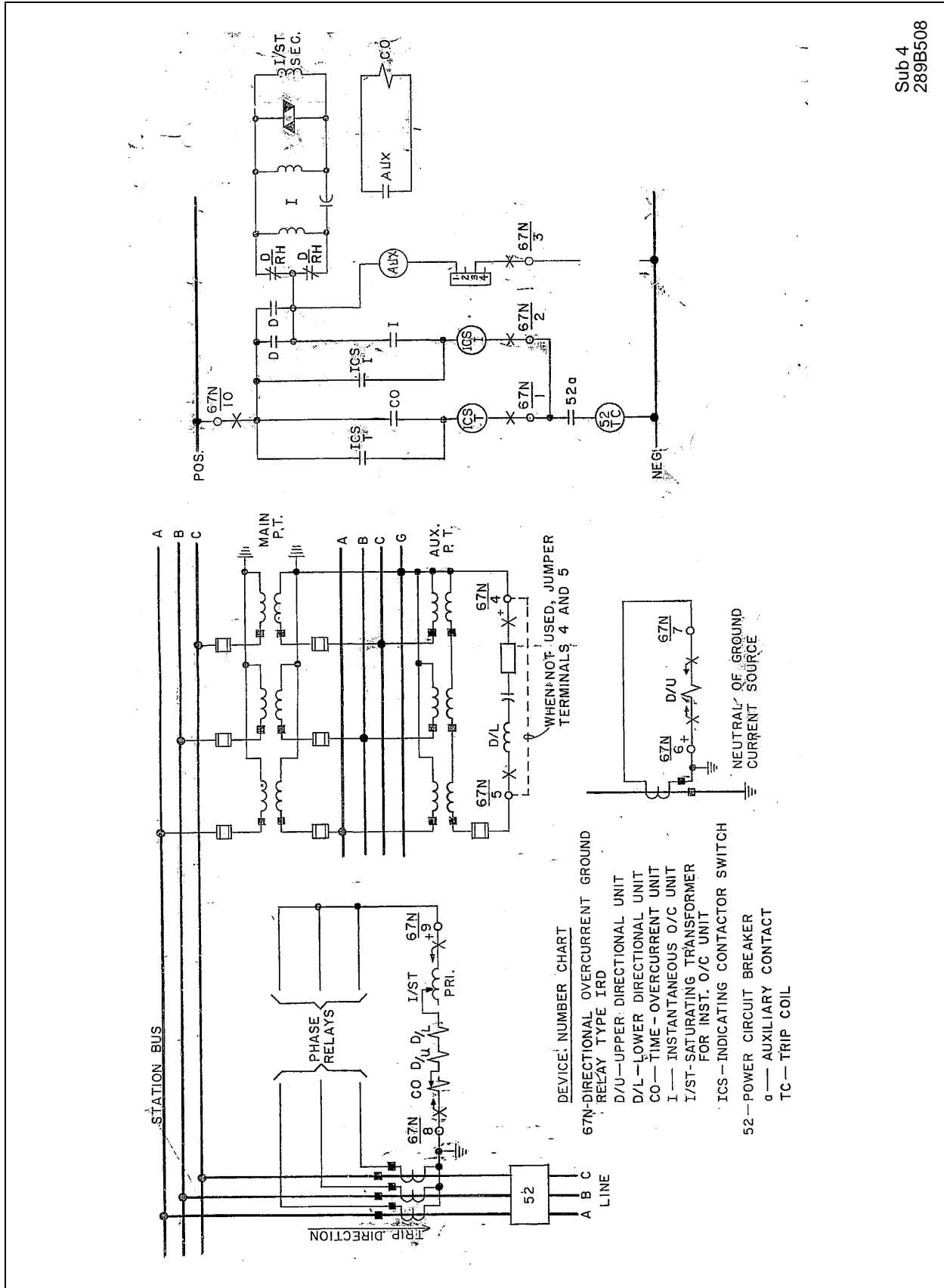

Figure 15: External Schematic of the IRD Relay for Ground Fault Protection.

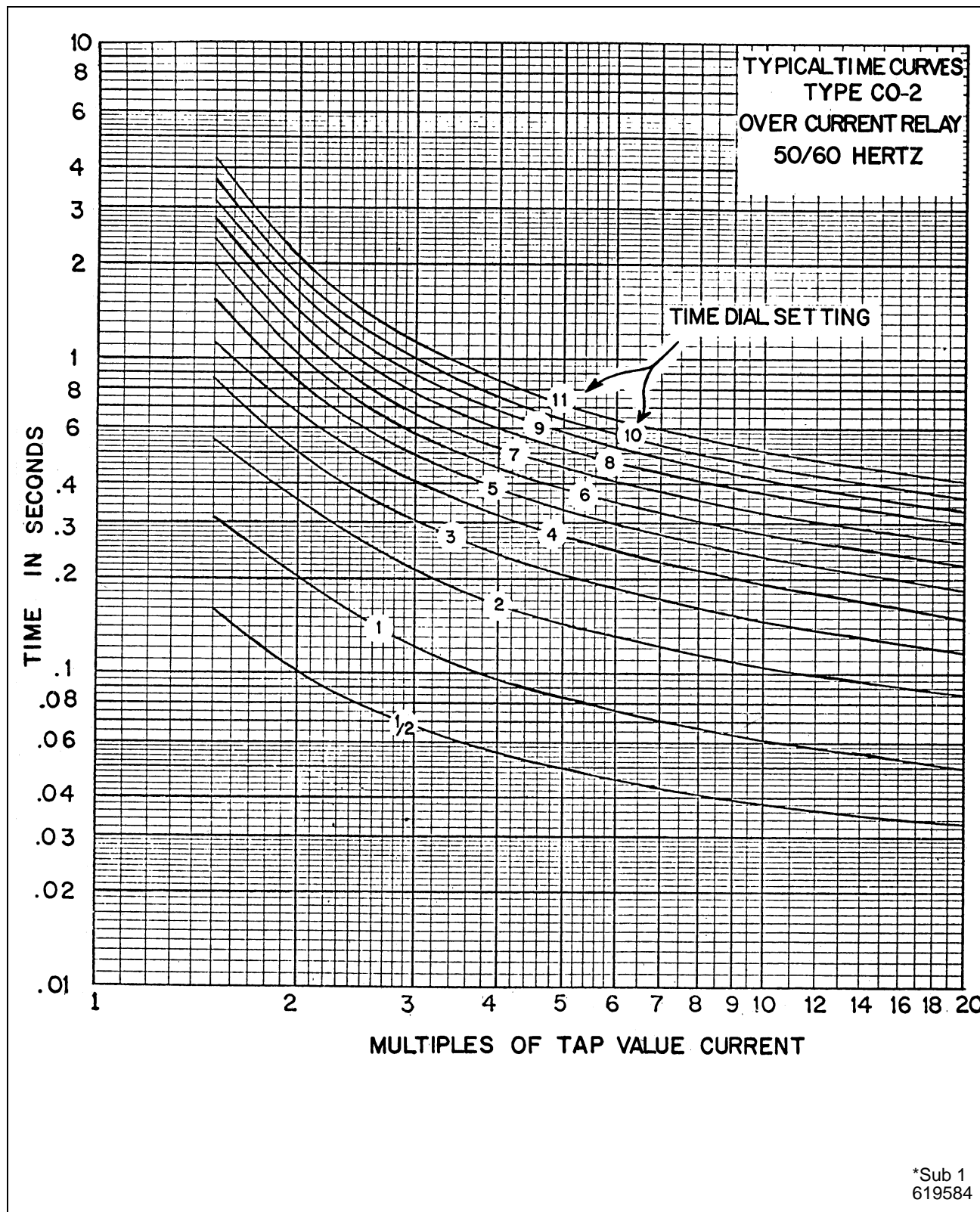

Figure 16: Typical Time Curves of the Time-Overcurrent Unit of the Short Time (2) Relays

*Denotes change since previous issue

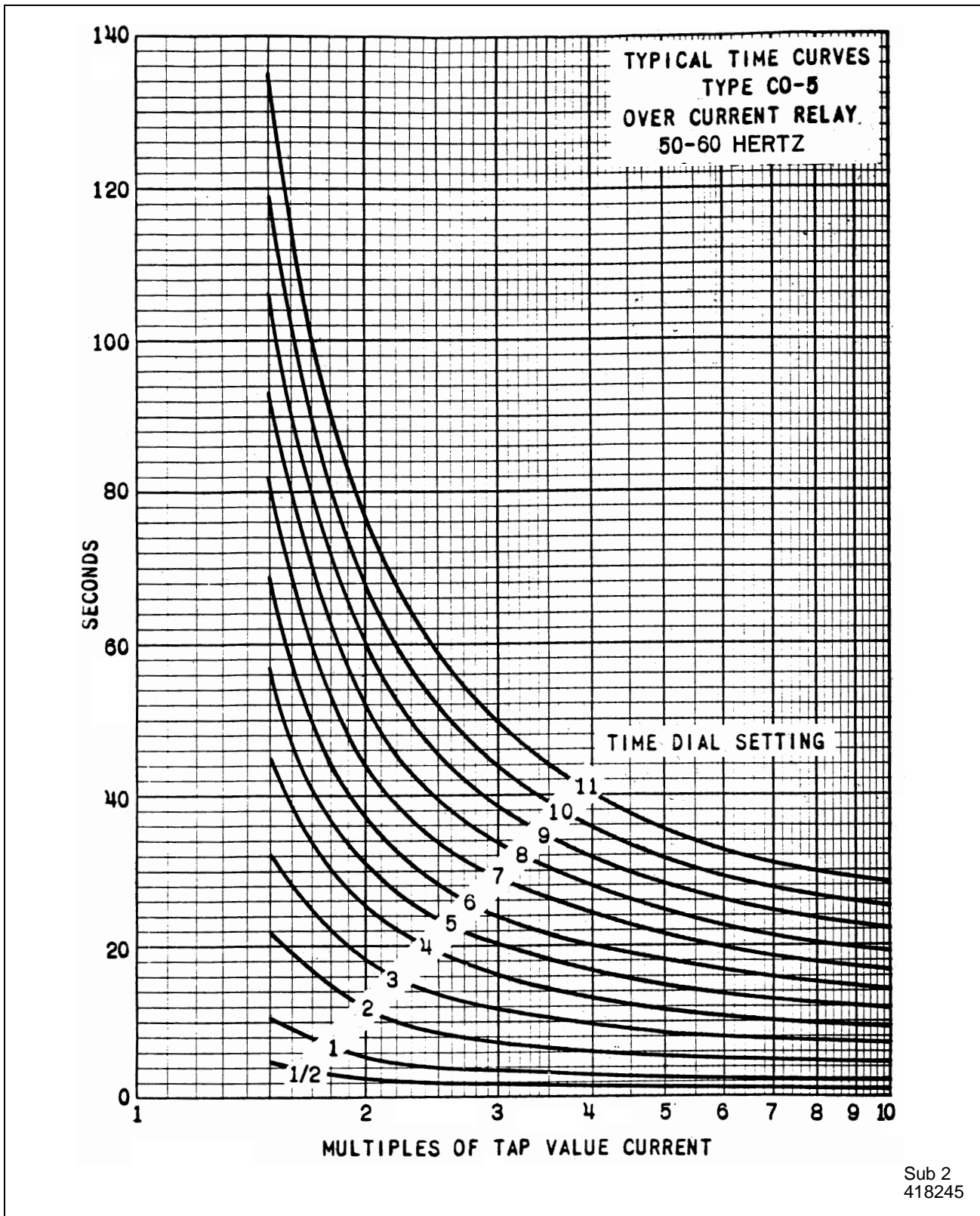

Figure 17: Typical Time Curves of the Time-Overcurrent Unit of the Long Time (5) Relays

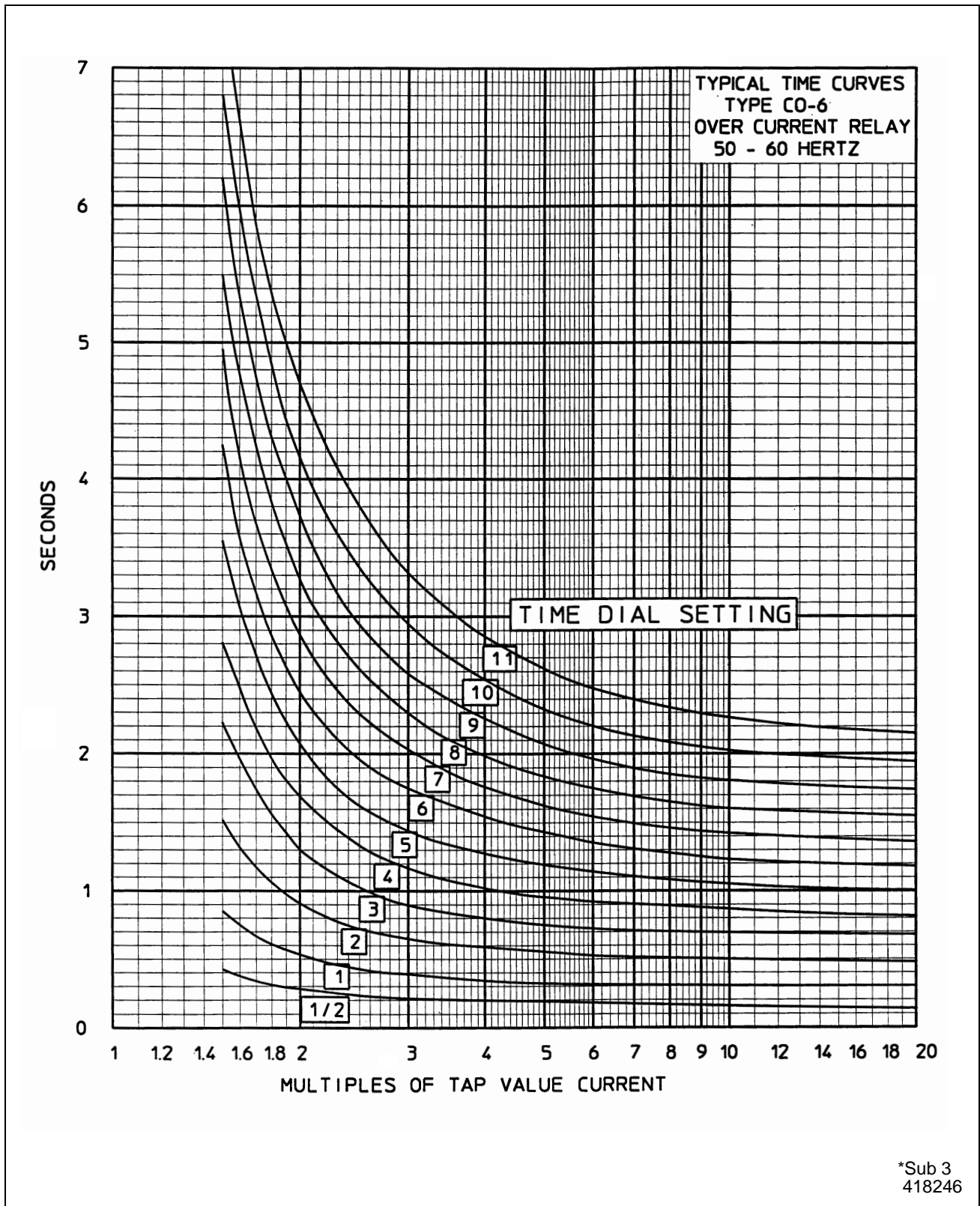

Figure 18: Typical Time Curve of the Time-Overcurrent Unit of the Definite Time (6) Relays

*Denotes change since previous issue

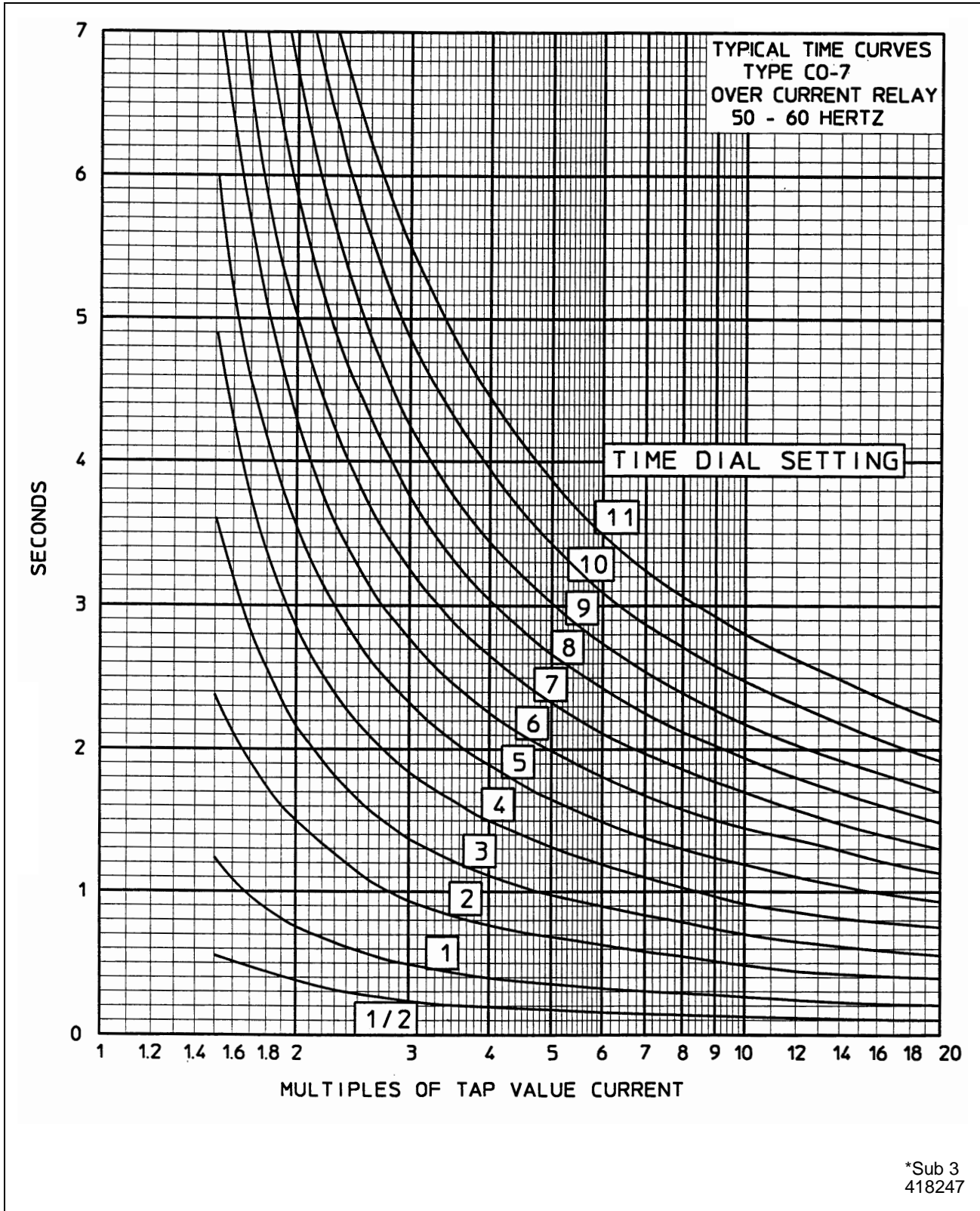

Figure 19: Typical Time Curve of the Time-Overcurrent Unit of the Definite Time (7) Relays.

*Denotes change since previous issue

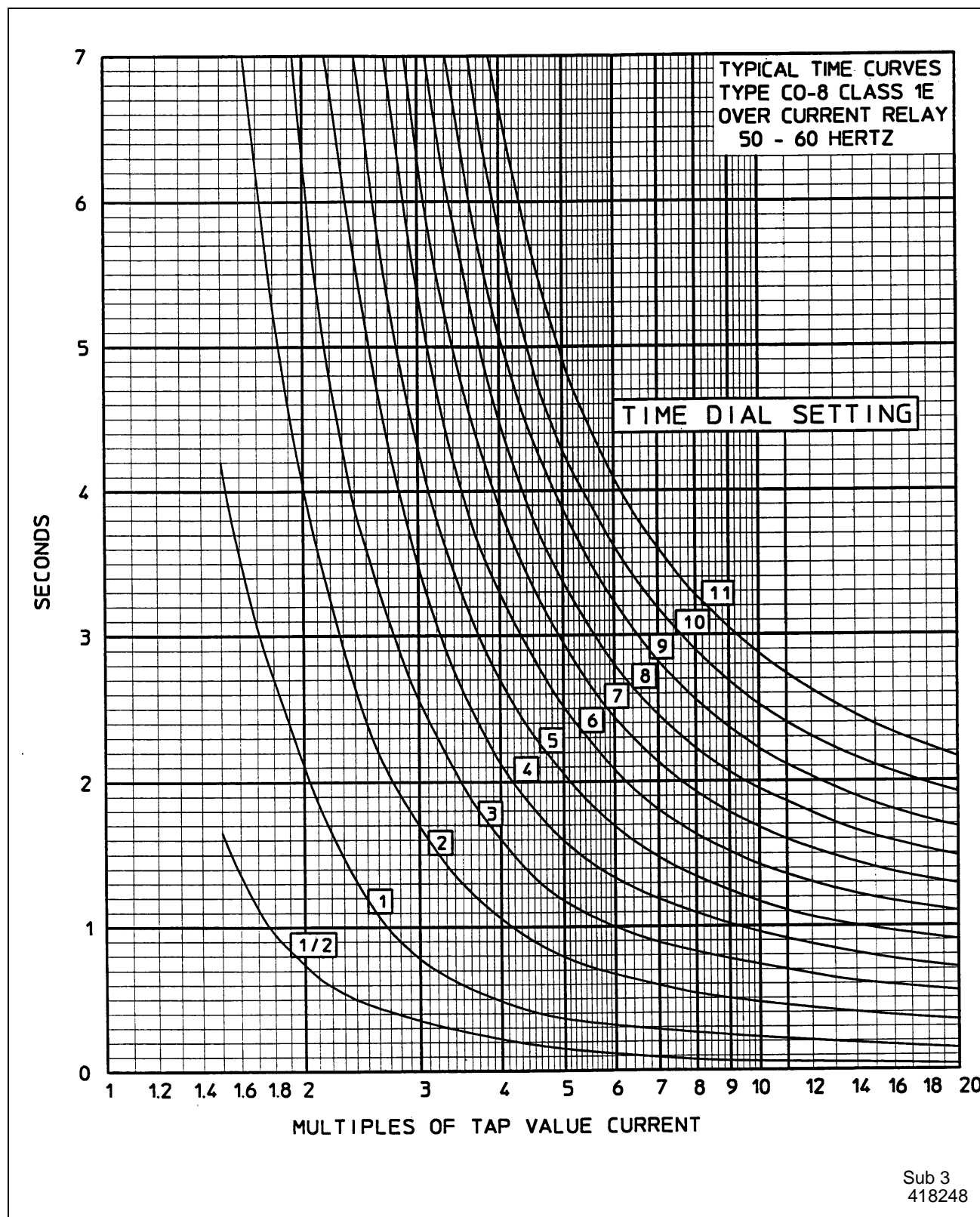

Figure 20: Typical Time Curve of the Time-Overcurrent Unit of the Definite Time (8) Relays.

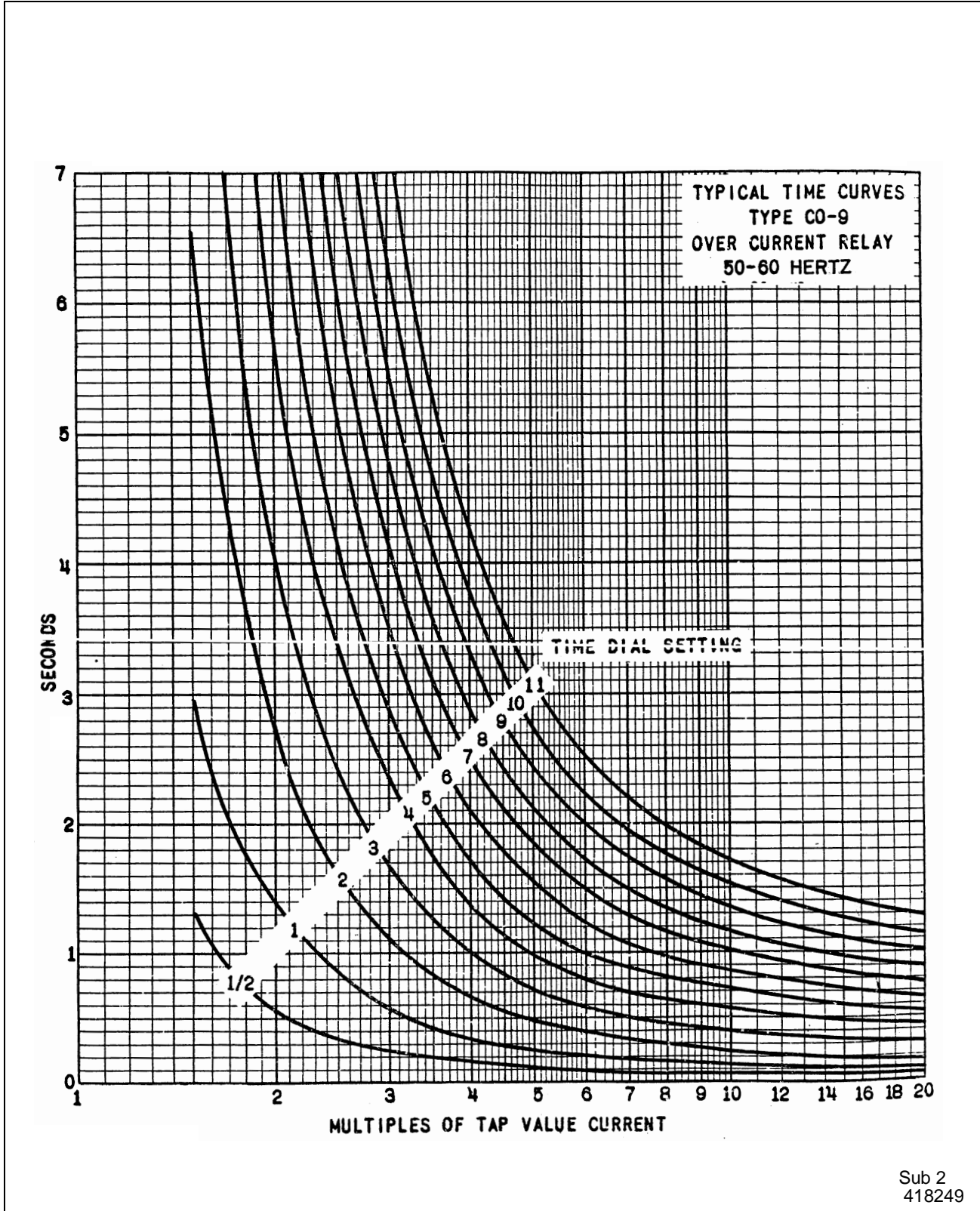

Figure 21: Typical Time Curve of the Time-Overcurrent Unit of the Definite Time (9) Relays.

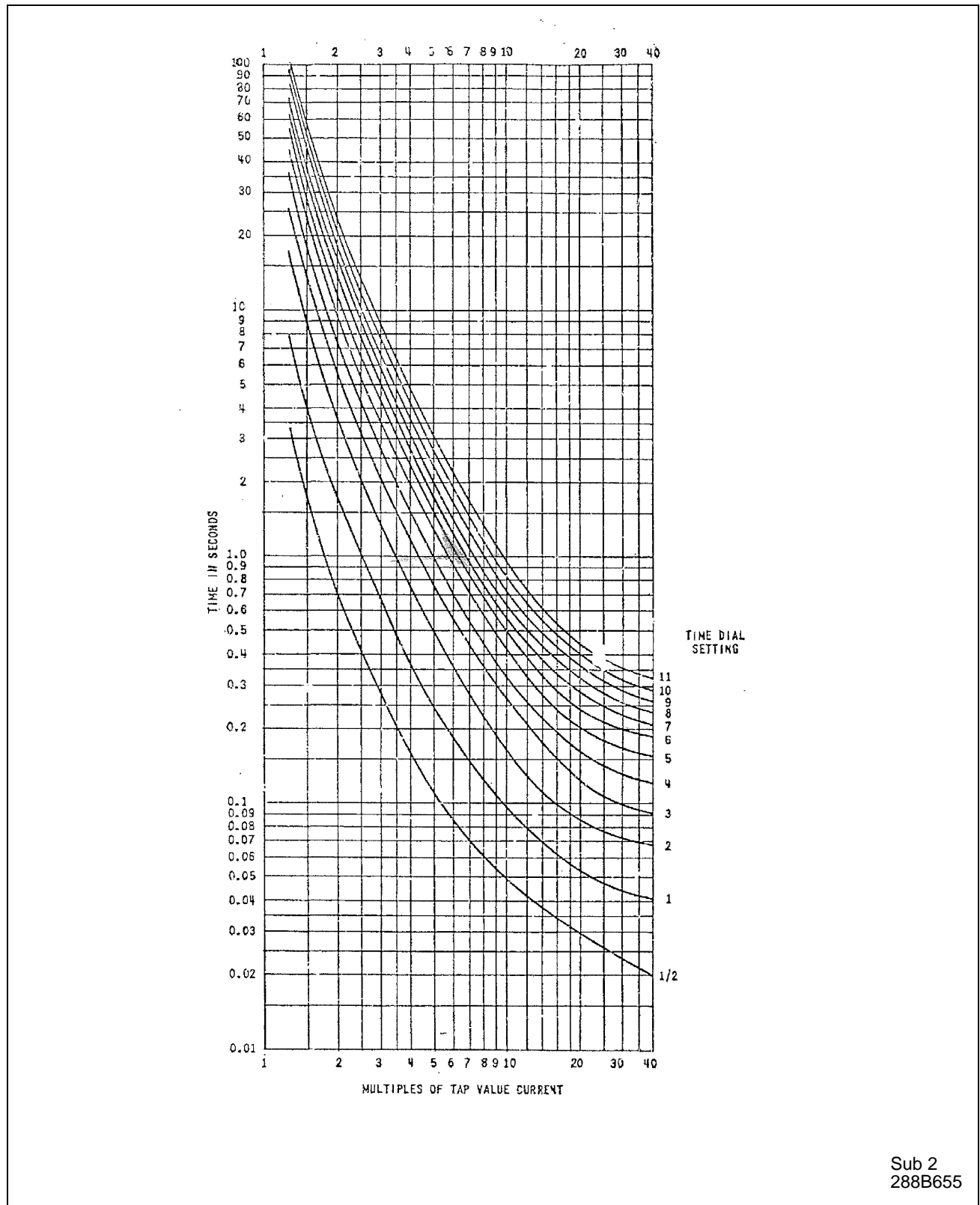

Figure 22: Typical Time Curve of the Time-Overcurrent Unit of the Definite Time (11) Relays.

Sub 2
288B655

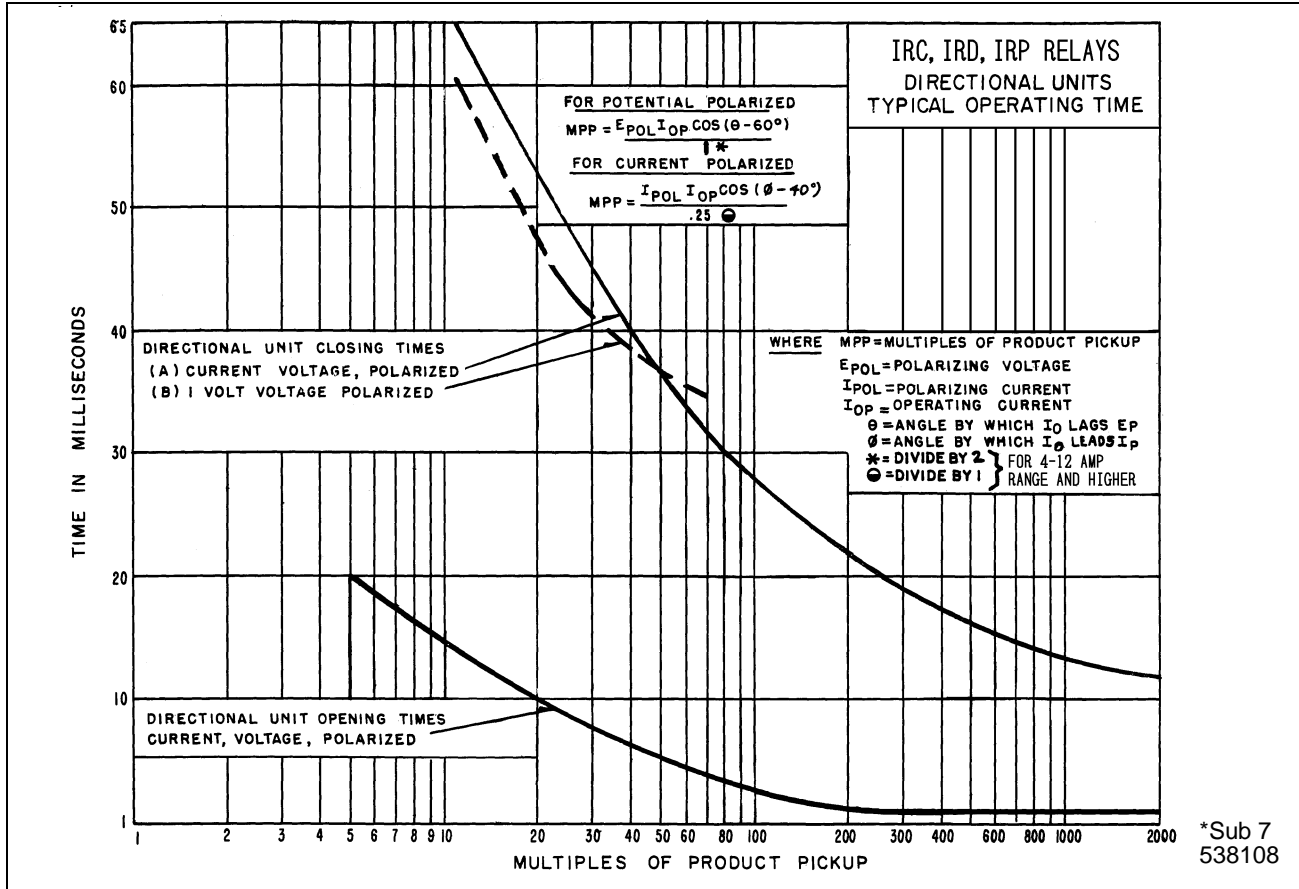

Figure 23: Typical Operating Times For The Directional Unit

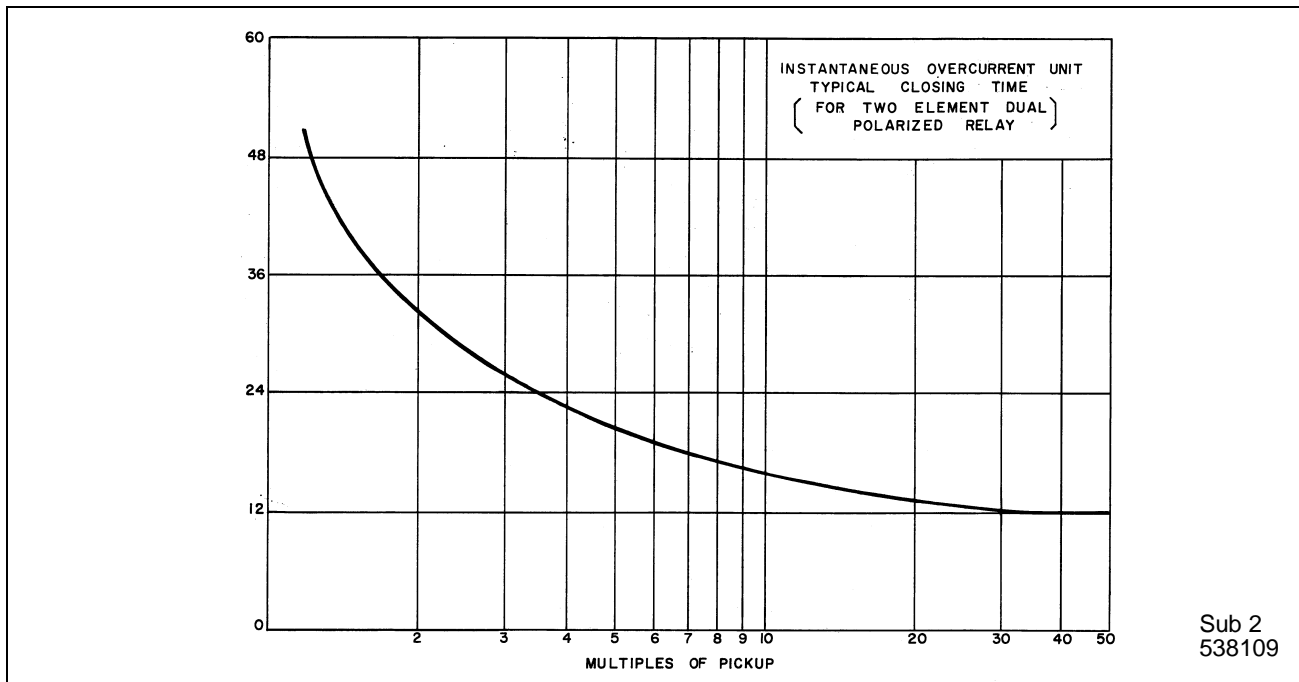
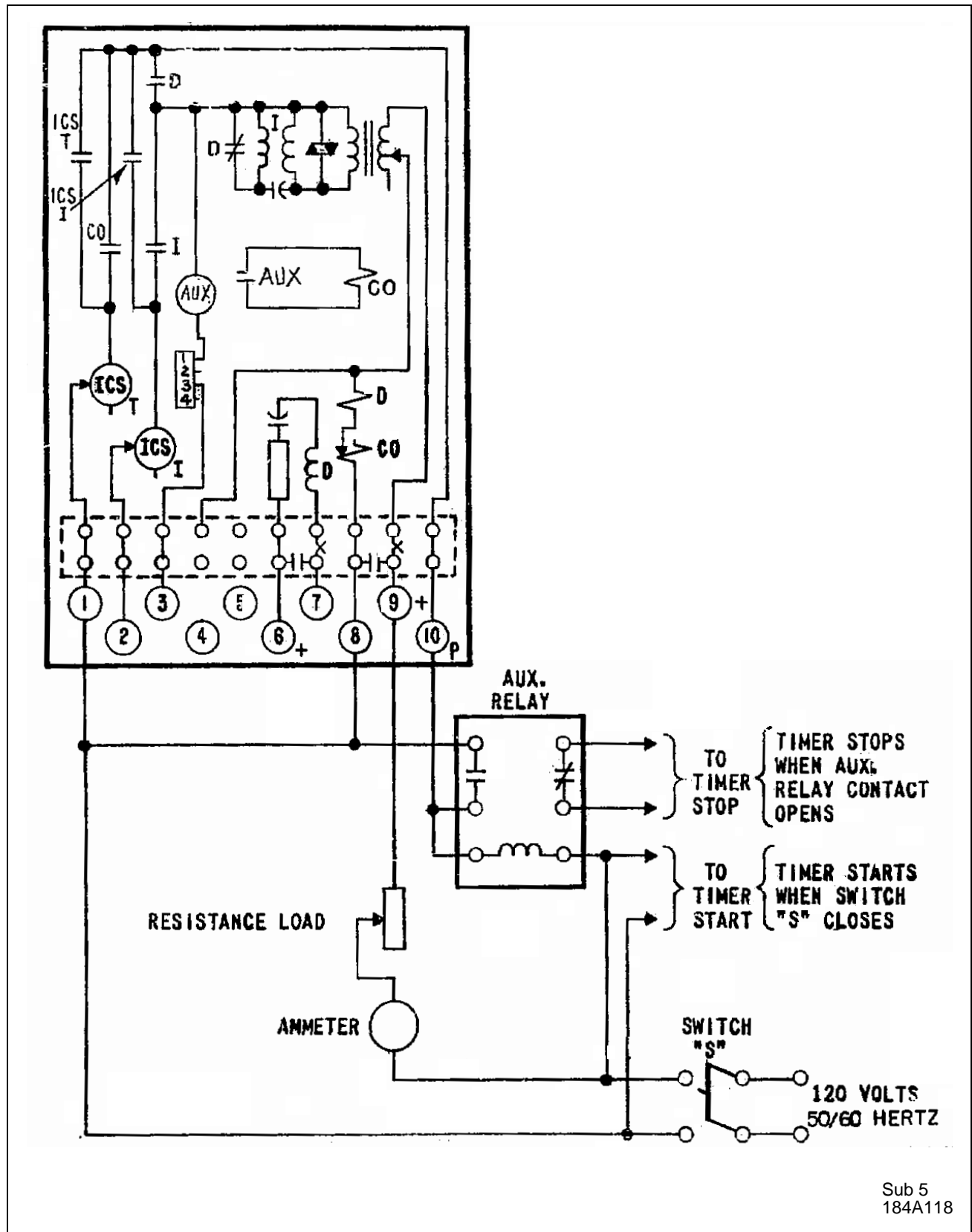

Figure 24: Typical Operating Times For the Instantaneous Overcurrent Unit

*Denotes change since previous issue



Sub 5
184A118

Figure 25: Diagram Of Test Connections Of The Time-Overcurrent Unit

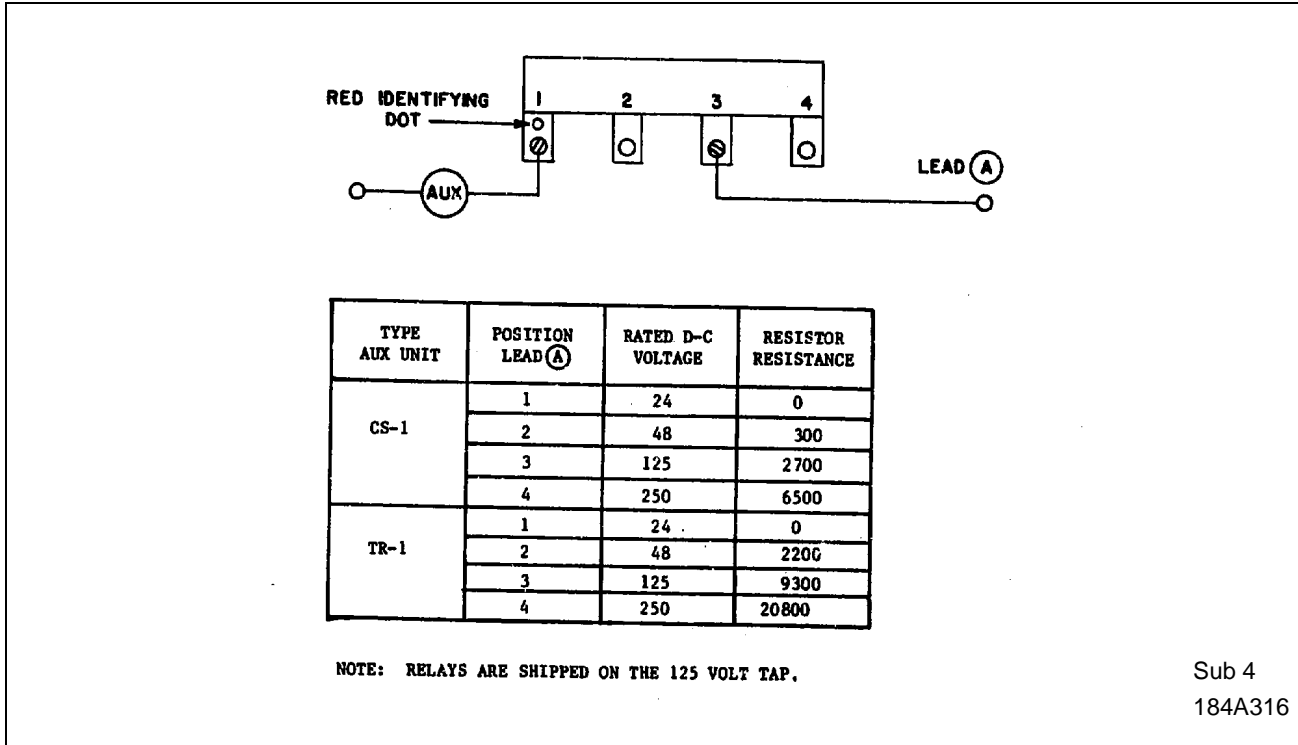

Figure 26: Selection of Proper Voltage Tap for Auxiliary Switch Operation

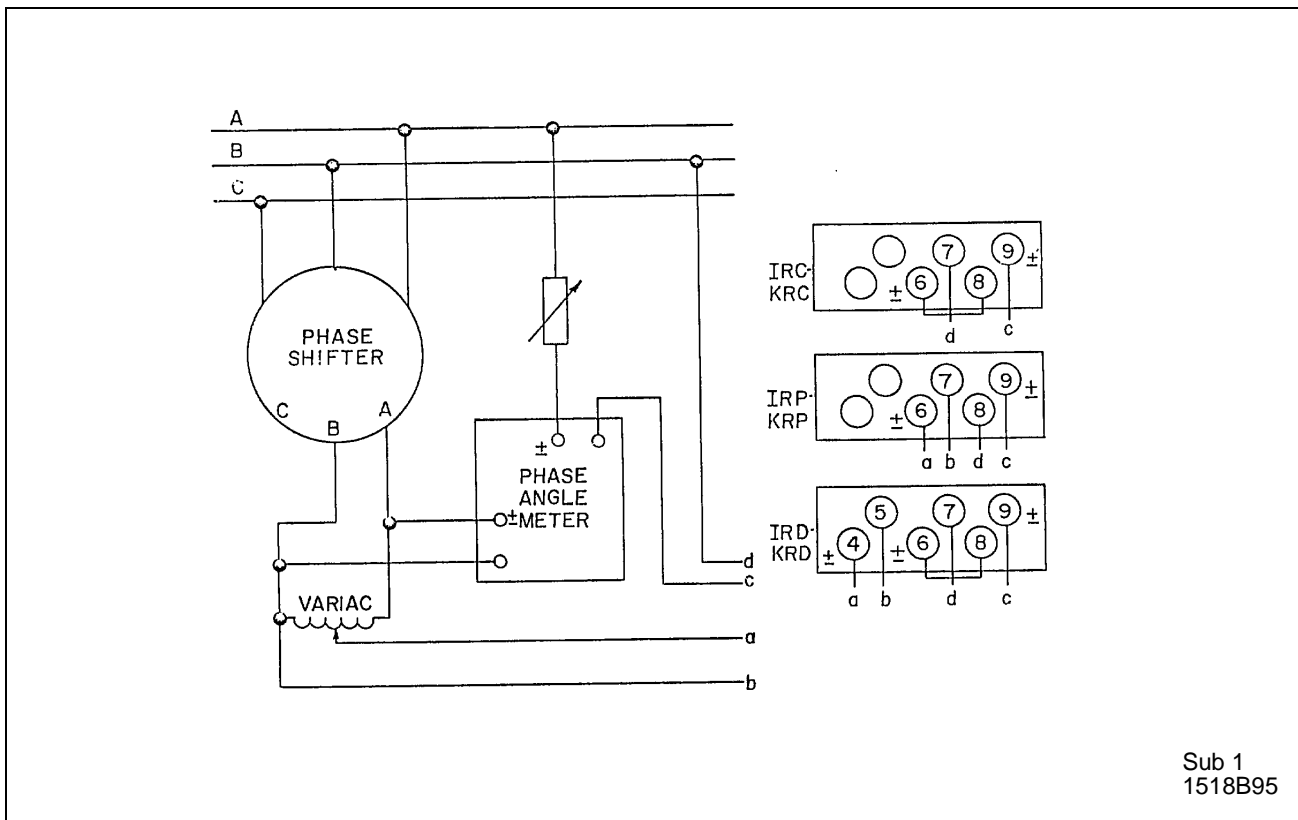

Figure 27: Test Connections

NOTES

NOTES

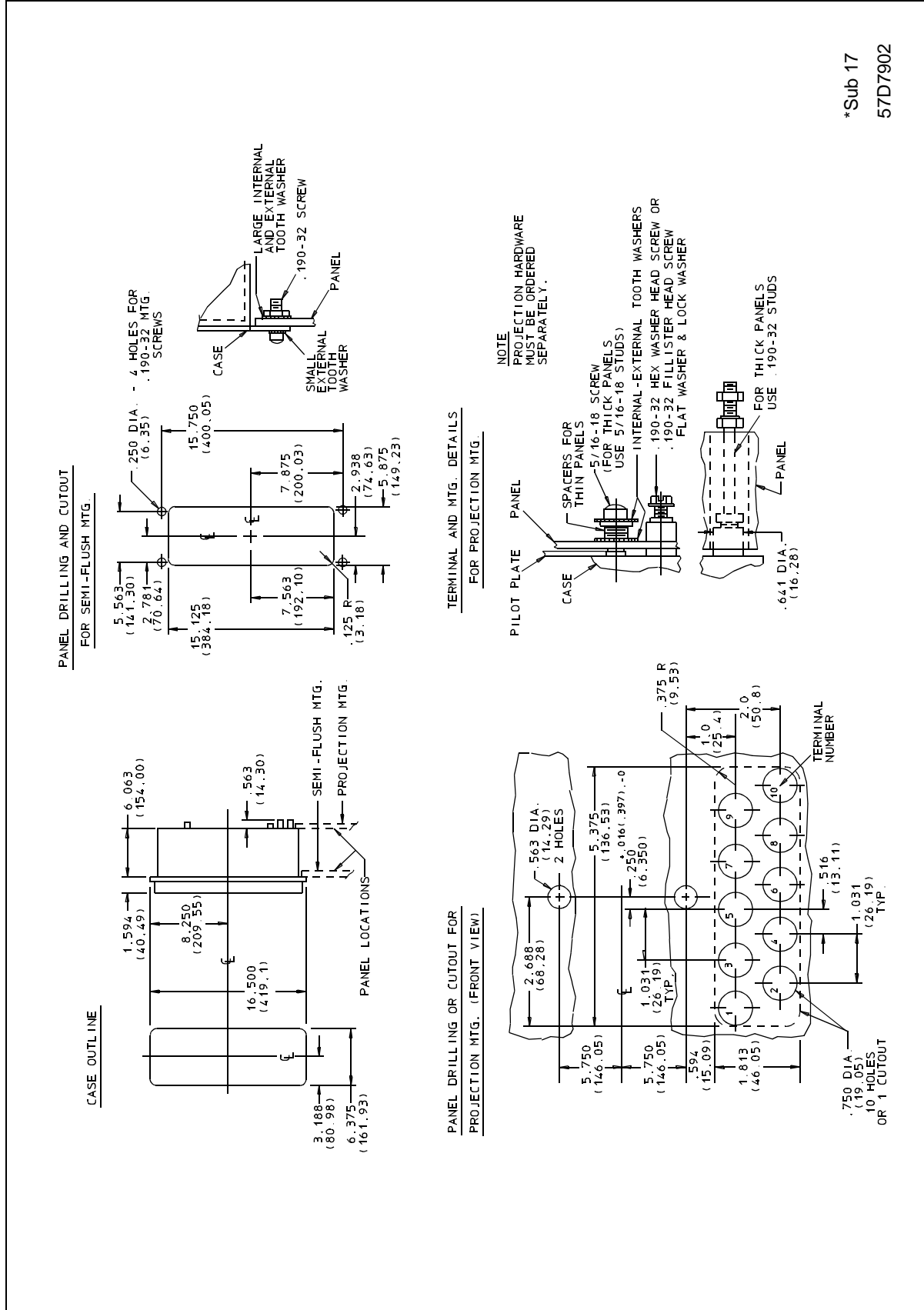

Figure 28: Outline and Drilling Plan for the IRP and IRC in the Type FT-31 Case.

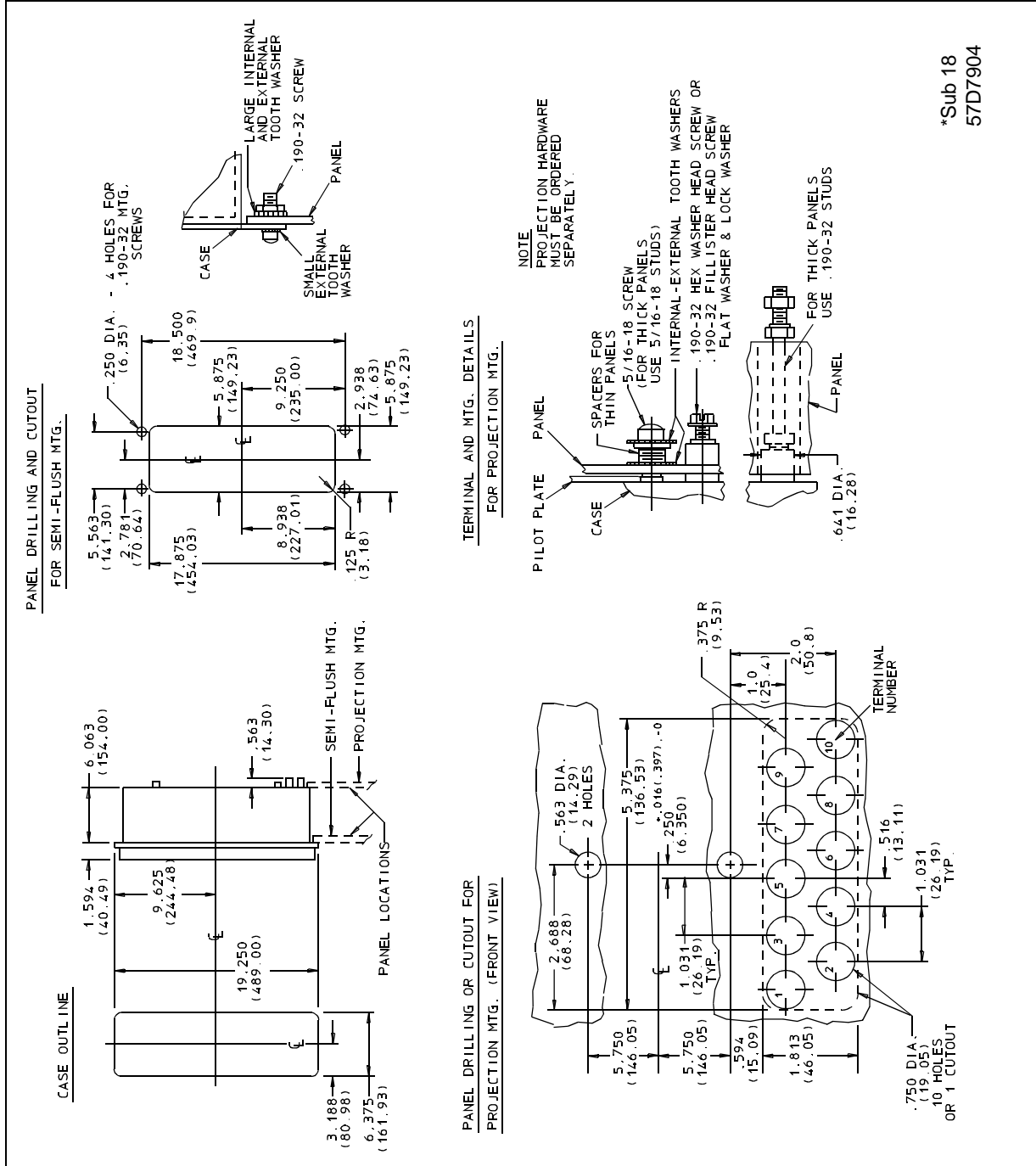

Figure 29: Outline and Drilling Plan for the IRD Relay in the Type FT41 Case.

